

IEEE P802.15.4a
Wireless Personal Area Networks

Project	IEEE P802.15 Working Group for Wireless Personal Area Networks (WPANs)	
Title	TG4a drafting	
Date Submitted	December 4, 2005	
Source	Jay Bain, Fearn Consulting	Voice: NONE Fax: NONE E-mail: jbain@hiwaay.net ,
Re:	Draft specification for 802.15.4a	
Abstract	UWB and CSS PHYs are combined with ranging and MAC content to provide the main structure of the TG4a draft.	
Purpose	To provide a working document for the TG4a draft.	
Notice	This document has been prepared to assist the IEEE P802.15. It is offered as a basis for discussion and is not binding on the contributing individual(s) or organization(s). The material in this document is subject to change in form and content after further study. The contributor(s) reserve(s) the right to add, amend or withdraw material contained herein.	
Release	The contributor acknowledges and accepts that this contribution becomes the property of IEEE and may be made publicly available by P802.15.	

PART 15.4: Wireless Medium Access Control (MAC) and Physical Layer (PHY) Specifications for Low-Rate Wireless Personal Area Networks (LR-WPANS)

Sponsor

LAN/MAN Standards Committee of the IEEE Computer Society

Abstract: This standard defines the protocol and compatible interconnection for data communication devices using low data rate, low power and low complexity, short-range radio frequency (RF) transmissions in a wireless personal area network (WPAN).

Keywords: ad hoc network, low data rate, low power, LR-WPAN, mobility, personal area network (PAN), radio frequency (RF), short range, wireless, wireless personal area network (WPAN)

Introduction

(This introduction is not part of IEEE Std 802.15.4a-200x, IEEE Standard for Information technology—Telecommunications and information exchange between systems—Local and metropolitan area networks—Specific requirements—Revision of Part 15.4: Wireless LAN Medium Access Control (MAC) and Physical Layer (PHY) Specifications for Low-Rate Wireless Personal Area Networks (LR-WPANS).)

IEEE Std 802.15.4a-200x

This standard defines the protocol and interconnection of devices via radio communication in a personal area network (PAN). The standard uses carrier sense multiple access with a collision avoidance medium access mechanism and supports star as well as peer-to-peer topologies. The media access is contention based; however, using the optional superframe structure, time slots can be allocated by the PAN coordinator to devices with time critical data. Connectivity to higher performance networks is provided through a PAN coordinator.

This amendment specifies two distinct PHYs: a UWB PHY at Frequencies of 3 – 5 GHz, 6 – 10 GHz, and less than 1 GHz and CSS PHY at 2450 MHz. The UWB PHY supports an over-the-air mandatory data rate of 842 kb/s, with optional data rates of 105kb/s, 3.37 Mb/s, 13.48 Mb/s, and 26.95 Mb/s.; the CSS PHY supports an over-the-air data rate of 1000 kb/s and optionally 250kb/s. The PHY chosen depends on local regulations, application, and user preference.

This standard contains state-of-the-art material. The area covered by this standard is undergoing evolution. Revisions are anticipated to this standard within the next few years to clarify existing material, to correct possible errors, and to incorporate new related material. Details on the contents of this standard are provided on the following pages. Information on the current revision state of this and other IEEE 802® standards may be obtained from:

Secretary, IEEE-SA Standards Board
445 Hoes Lane
P.O.Box 1331
Piscataway, NJ 08855-1331
USA

Participants

At the time the draft of this standard was sent to sponsor ballot, the IEEE P802.15™ Working Group had the following voting members:

Robert F. Heile, *Chair*
Richard Alfvín, *Vice Chair*
James D. Allen, *Vice Chair*
Patrick W. Kinney, *Vice Chair*
Patrick W. Kinney, *Secretary*
Michael D. McInnis, *Assistant Secretary and Editor*

Jim Lansford, *Task Group 3a Co-Chair*
Gregg Razor, *Task Group 3a Co-Chair*
John R. Barr, *Task Group 3b Chair*
Reed Fisher, *Task Group 3c Chair*
Robert Poor, *Task Group 4b Chair*
Myung Lee, *Task Group 5 Chair*

Patrick W. Kinney, *Task Group 4a Chair*
John Lampe, *Task Group 4b Co-Editor-in-Chief*
Patrick Houghton, *Task Group 4b Secretary*
Vern Brethour, *Ranging Technical Editor*
Zafer Sahinoglu, *Ranging Technical vice-Editor*
Phil Orlik, *UWB co-Technical editor*
Ismail Lakkis, *UWB co-Technical editor*
John Lampe, *CSS Technical editor*
Jay Bain, *MAC Technical editor*
Philippe Rouzet, *Task Group 4b Co-Editor-in-Chief Emeritus*

Jon Adams
 Roberto Aiello
 Richard Alfvín
 James Allen
 Kyu Hwan An
 Mikio Aoki
 Yasuyuki Arai
 Takashi Arita
 Larry Arnett
 Naiel Askar
 Arthur Astrin
 Yasaman Bahreini
 Jay Bain
 feng Bao
 John Barr
 Phil Beecher
 Alan Berkema
 Bruce Bosco
 Monique Bourgeois Brown
 Mark Bowles
 Charles Brabenac
 David Brenner
 Vern Brethour
 Ronald Brown
 Ed Callaway

Bill Carney
 Pat Carson
 Kuor-Hsin Chang
 Soo-Young Chang
 Jonathon Cheah
 Francois Chin
 Kwan-Wu Chin
 Sarm-Goo Cho
 Sangsung Choi
 Yun Choi
 Chia-Chin Chong
 Chun-Ting Chou
 Manoj Choudhary
 Celestino Corral
 Robert Charles Cragie
 Joe Decuir
 Javier Del Prado Pavon
 Kai Dombrowski
 Stefan Drude
 Eryk Dutkiewicz
 Michael Dydyk
 Amal Ekbal
 Jason Ellis
 Shahriar Emami
 Yew Soo Eng

Paul Everest
 Mark W. Fidler
 Reed Fisher
 Kristoffer Fleming
 Amir Freund
 Ricardo Gandia Sanchez
 Ian Gifford
 James Gilb
 Eric Gnoske
 Sung-Wook Goh
 Sorin Goldenberg
 Paul Gorday
 Bernd Grohmann
 Rainer Hach
 Julian Hall
 Robert Hall
 Shinsuke HARA
 Jeff Harris
 Vann Hasty
 Allen Heberling
 Robert Heile
 Eric Heinze
 Barry Herold
 Jin-Meng Ho
 Patrick Houghton

Robert Huang
 Xiaojing Huang
 Akira Ikeda
 Hideto Ikeda
 Tetsushi Ikegami
 Oyvind Janbu
 Yeong Min Jang
 Adrian Jennings
 Ho-In Jeon
 Tzyy Hong Jiang (Chiang)
 Jeyhan Karaoguz
 Michael Kelly
 Stuart Kerry
 Haksun Kim
 Jae-Hyon Kim
 Jaeyoung Kim
 JinKyeong Kim
 Yongsuk Kim
 Young Hwan Kim
 Kursat Kimyacioglu
 Matthias Kindler
 Patrick Kinney
 Guenter Kleindl
 Ryuji Kohno
 Mike Krell
 Yasushi Kudo
 Haim Kupershmidt
 Yuzo Kuramochi
 Kyung Sup Kwak
 Jun-You Lai
 Ismail Lakkis
 John Lampe
 Jim Lansford
 Colin Lanzl
 Kyung Kuk Lee
 Myung Lee
 Wooyong Lee
 David Leeper
 Henry Li
 Huan-Bang Li
 Liang Li
 Haixiang Liang
 Darryn Lowe
 Ian Macnamara
 Tadahiko Maeda
 Akira Maeki
 Patricia Martigne
 Frederick Martin
 Abbie Mathew
 Taisuke Matsumoto
 Masafumi Matsumura
 Michael Mc Laughlin
 John McCorkle
 Michael McInnis

Charlie Mellone
 Jim Meyer
 Klaus Meyer
 Akira Miura
 Samuel Mo
 Andreas Molisch
 Mark Moore
 Marco Naeve
 Ken Naganuma
 Yves Paul Nakache
 Hiroyuki Nakase
 Saishankar Nandagopalan
 Chiu Ngo
 Erwin Noble
 Mizukoshi Nobuyuki
 Masaki Noda
 John (Jay) O'Conor
 Knut Odman
 Hiroyo Ogawa
 Yasuyuki Okuma
 Philip Orlik
 Laurent Ouvry
 John Pardee
 Young Jin Park
 Nirmalendu Patra
 Dave Patton
 Xiaoming Peng
 Tony Pollock
 Robert Poor
 Clinton Powell
 Vidyasagar Premkumar
 Yihong Qi
 Raad Raad
 Ajay Rajkumar
 Pekka Ranta
 Dani Raphaeli
 Gregg Rasor
 Charles Razzell
 Joseph Reddy
 Ivan Reede
 Yuko Rikuta
 Terry Robar
 Glyn Roberts
 Richard Roberts
 Martin Rofheart
 Benjamin Rolfe
 Philippe Rouzet
 Chandos Rypinski
 Saeid Safavi
 Zafer Sahinoglu
 Tomoki Saito
 Syed Saleem
 John Sarallo
 Sidney Schrum

Erik Schylander
 Alireza Seyedi
 Sanjeev Sharma
 Stephen Shellhammer
 Siddharth Shetty
 John (Chih-Chung) Shi
 Shusaku Shimada
 Yuichi Shiraki
 Gadi Shor
 William Shvodian
 Thomas Siep
 Michael Sim
 Kazimierz Siwiak
 Zachary Smith
 V. Somayazulu
 Carl Stevenson
 Marinus Struik
 Kazuaki Takahashi
 Kenichi Takizawa
 Teik-Kheong Tan
 Mike Tanahashi
 James Taylor
 John Terry
 Arnaud Tonnerre
 Jarvis Tou
 Jerry Upton
 Robin Vaitonis
 Bart Van Poucke
 Nanci Vogtli
 Jerry Wang
 Jing Wang
 Chris Weber
 Matthew Welborn
 Richard Wilson
 Gerald Wineinger
 Andreas Wolf
 Marcus Wong
 Stephen Wood
 Patrick Worfolk
 Tracy Wright
 Xiaodong Wu
 Yu-Ming Wu
 Hirohisa Yamaguchi
 Kanya Yekeh Yazdandoost
 Su-Khiong Yong
 Zhan Yu
 Serdar Yurdakul
 Honggang Zhang
 Bin Zhen
 Frank Xiaojun Zheng
 Zheng Zhou
 Chunhui Zhu

Major contributions were received from the following individuals:

To be added

The following members of the balloting committee voted on this standard:

[IEEE] List of balloting committee members goes here

When the IEEE-SA Standards Board approved this standard on xx YYY 200x, it had the following membership:

[IEEE] To be added

Also included are the following nonvoting IEEE-SA Standards Board liaisons:

[IEEE] To be added

NOTE—The editing instructions contained in this amendment define how to merge the material contained therein into the existing base standard and its amendments to form the comprehensive standard.

The editing instructions are shown in ***bold italic***. Four editing instructions are used: change, delete, insert, and replace. ***Change*** is used to make corrections in existing text or tables. The editing instruction specifies the location of the change and describes what is being changed by using ~~strike through~~ (to remove old material) and underscore (to add new material). ***Delete*** removes existing material. ***Insert*** adds new material without disturbing the existing material. Insertions may require renumbering. If so, renumbering instructions are given in the editing instruction. ***Replace*** is used to make changes in figures or equations by removing the existing figure or equation and replacing it with a new one. Editorial notes will not be carried over into future editions because the changes will be incorporated into the base standard

1. Overview	5
2. References	5
3. Definitions	5
4. Abbreviations	5
5. General Description	5
5.4 <i>Functional Overview</i>	5
5.4.4 Robustness	5
5.4.4.1a Aloha protocol	5
5.4.7 Ranging	5
5.4.7.1 Ranging mechanisms	5
5.4.7.2 Ranging accuracy	6
5.4.7.3 Ranging privacy	6
6. PHY Specification	7
6.1 General requirements and definitions	7
6.1.1 Operating frequency range	7
6.1.2 Channel assignments	7
6.1.2.1 Channel numbering	8
6.1.2.1a Channel numbering for CSS PHY	8
6.1.2.1b Channel numbering for UWB PHY	8
6.1.2.2 Channel pages.....	9
6.1.3 Minimum LIFS and SIFS periods	9
6.2 PHY Service Specifications	10
6.2.1. PHY Data Service	10
6.2.1.1. PD-Data.request	10
6.2.1.2 PD-Data.confirm	10
6.2.1.3 PD-Data.indication.....	11
6.3 PPDU Format	11
6.3.1 General packet format	11
6.3.1.1 Preamble field	12
6.3.1.2 SFD field	12
6.3.1.2a UWB rate field	12
6.4 PHY Constants and PIB attributes	13
6.4.1 PHY constants.....	13
6.4.2 PIB Attributes	14
6.5a 2450 MHz PHY Chirp Spread Spectrum (CSS) PHY	15
6.5a.1 Data rates.....	15
6.5a.2 Modulation and spreading.....	15
6.5a.2.1 Reference Modulator Diagram.....	15
6.5a.2.2 De-Multiplexer (DEMUX)	16
6.5a.2.3 Serial to Parallel Mapping (S/P).....	16
6.5a.2.4 Data Symbol - to - Bi-Orthogonal Code Word mapping	16
6.5a.2.5 Parallel - to - Serial Converter (P/S) and QPSK Symbol Mapping	18
6.5a.2.6 Differential-QPSK (DQPSK) Coding	18
6.5a.2.7 DQPSK - to - DQCSK modulation	18
6.5a.2.8 CSK Generator	18

6.5a.3 Preamble.....	18
6.5a.4 Waveform and Sub-Chirp Sequences.....	19
6.5a.4.1 Graphical presentation of chirp symbols (sub-chirp sequences).....	19
6.5a.4.2 Active usage of time gaps.....	19
6.5a.4.3 Mathematical representation of the continuous time CSS Base-band signal.....	20
6.5a.4.4 the Raised Cosine Window for Chirp Pulse Shaping	21
6.5a.4.5 Sub-Chirp transmission order	22
6.5a.5 2450 MHz band radio specification	22
6.5a.5.1 Transmit power spectral density (PSD) mask.....	22
6.5a.5.2 Symbol rate	22
6.5a.5.3 Receiver sensitivity	23
6.5a.5.4 Receiver Jamming Resistance (Informative)	23
6.8a. 3100 to 10000MHz PHY Ultra Wide Band (UWB)	23
6.8a.1 Data Rates	23
6.8a.2 Ranging/Acquisition Symbol (Preamble).....	24
6.8a.2.1 Extension of Preamble for optional CCA modes.....	25
6.8a.3 Waveform, Pulse Shape, and Chipping Rates	27
6.8a.3.1 Structure of a UWB PHY symbol	27
6.8a.3.2 UWB PHY Symbol Timing Details	28
6.8a.4. UWB PHY Spreading and Hopping Sequences	40
6.8a.5. UWB PHY Channel coding within a band.....	41
6.8a.6. UWB PHY Forward Error Correction.....	41
6.8a.6.1 Reed Solomon Default Codeword Operation	41
6.8a.6.2 Inner Convolution Coder Operation	42
6.9 General radio specifications	43
6.9.1 TX-to-RX turnaround time	43
6.9.2 RX-to-TX turnaround time	43
6.9.3 Error-vector magnitude (EVM) definition	43
6.9.3.1 EVM calculated values	44
6.9.4 Transmit center frequency tolerance	44
6.9.5 Transmit power	44
6.9.6 Receiver maximum input level of desired signal	44
6.9.7 Receiver ED	45
6.9.8 LQI	45
6.9.9 CCA	46
7. MAC Sub-Layer Specification	47
7.1 MAC Sub-Layer Service Specification	47
7.1.1 MAC Data Service.....	47
7.1.1.1 MCPS-DATA.request.....	47
7.1.1.2 MCPS-DATA.confirm	48
7.1.1.3 MCPS-DATA.indication	49
7.2 MAC Frame Formats	50
7.2.2.4 MAC command frame format	50
7.3 MAC Command Frames	51
7.3.4 Private Ranging	51
7.3.4.1 Range notification	51
7.4 MAC Constants and PIB Attributes	52
7.5 MAC Functional Description	53
7.5.7a Ranging	53
7.5.7a.1 Classes of Service	53
7.5.7a.2 Message Timestamps.....	54

7.5.7a.3 Mitigation of relative crystal drift.....	54
7.5.7a.4 Non-private ranging.....	54
7.5.7a.5 Private ranging	55
7.5.7a.6 MAC command to initiate two way ranging	57
7.5.7a.7 The two-way ranging initiate packet	57
7.5.7a.8 The two-way ranging response packet	58
7.5.7a.9 Timestamp report message	58
7.5.7b UWB option management	58
7.5.7b.1 Data rates.....	59
Annex C	60
C.7 PICS proforma tables	60
C.7.2.3 RF	60
Annex D1 (informative) Location Topics for use of the IEEE 802.15.4a standard	61
D1.1 Parameter (Range or Direction) Estimation Techniques	61
D1.1.1 Range Estimation	61
D1.1.1a Time-of-Arrival (TOA)	61
D1.1.1a.1 Synchronous one-way ranging (OWR).....	61
D1.1.1a.2 Asynchronous two-way ranging (TWR)	62
D1.1.1a.3 Asynchronous symmetric doubly-sided two-way ranging (SDS-TWR)....	62
D1.1.1b Time-Difference-of-Arrival (TDOA)	62
D1.1.1c Time Sum of Arrival (TSOA)	63
D1.1.1d Signal Strength Ranging (SSR)	63
D1.1.2 Direction Estimation: Angle-of-Arrival (AOA)	63
D1.1.3 Combined Range and Direction Estimation	64
D1.2 Location Estimation Algorithms	64
D1.2a Location Estimation from Range Data	64
D1.2a.1 Isolating outliers in the range data.....	64
D1.2b Location Estimation from Direction Data	64
D1.3. Leading Edge Detection	64
D1.3.1 Coherent delay estimation with low sampling rate and feasible ADC implementation	65
D1.3.2 A First-arrival Detection Method	65
D1.4 Error Induced by Timing Crystal Offset	65
D1.4.1 The effect on the preamble and channel-sounding segments	65
D1.4.2 The effect on the ranging accuracy.....	65
Annex E (informative) Coexistence with other IEEE standards and proposed standards ... 67	
E.1 Standards and proposed standards characterized for coexistence with IEEE 802.15.4 and 802.15.4a CSS devices	67
E.2 General coexistence issues for IEEE 802.15.4 and 802.15.4a CSS devices	67
E.2.6a Channel alignment	67
E.3 Coexistence performance for IEEE 802.15.4 and 802.15.4a CSS devices	68
E.3.1 Assumptions for coexistence quantification	68
E.3.1.1 Channel model	68
E.3.1.2 Receiver sensitivity.....	68
E.3.1.3 Transmit power	68
E.3.1.4 Receiver bandwidth	68
E.3.1.5 Transmit spectral masks	68

E.3.1.6 IEEE 802.11b transmit PSD	69
E.3.1.7 Interference characteristics	69
E.3.1.8 Bit error rate (BER) calculations	69
E.3.1.9 PER	69
E.3.2 BER model	69
E.3.3 Coexistence simulation results	70
E.4 Notes on the calculations	77
E.5 Standards and proposed standards characterized for coexistence with IEEE 802.15.4a UWB devices between 3.1 and 10.6 GHz	77
E.6 General coexistence issues for IEEE 802.15.4a UWB devices between 3.1 and 10.6 GHz	78
E.7 Coexistence performance for IEEE 802.15.4a UWB devices between 3.1 and 10.6 GHz	78
E.8 Standards and proposed standards characterized for coexistence with IEEE 802.15.4a sub-GHz UWB devices	78
E.9 General coexistence issues for IEEE 802.15.4a sub-GHz UWB devices	78
E.10 Coexistence performance for IEEE 802.15.4a sub-GHz UWB devices	78
Annex F (informative) Regulatory requirements	79
F.1. IEEE 802.15.4	79
F.1.1 Introduction	79
F.1.2 Applicable U.S. (FCC) rules	79
F1.2.1 Section 15.35 of FCC CFR47	79
F1.2.2 Section 15.209 of FCC CFR47	79
F1.2.3 Section 15.205 of FCC CFR47	79
F1.2.4 Section 15.247 of FCC CFR47	79
F1.2.5 Section 15.249 of FCC CFR47	79
F.1.3 Applicable European rules	79
F1.3.1 European 2400 MHz band rules	79
F1.3.2 European 868–870 MHz band rules	79
F.1.4 Known Japanese rules	79
F.1.5 Emissions specification analysis with respect to known worldwide	79
F.1.5.1 General analysis and impact of detector bandwidth and averaging rules ...	79
F.1.5.2 Frequency spreading and averaging effects specific to IEEE 802.15.4	79
F.1.6 Summary of out-of-band spurious emissions limits	79
F.1.7 Phase noise requirements inferred from regulatory limits	79
F.1.8 Summary of transmission power levels	79
F.2. IEEE 802.15.4a UWB	79
F.2.1 Introduction	79
F.2.2 Applicable U.S. (FCC) rules	79
F.2.3 Applicable European rules	80
F.2.4 Applicable Japanese rules	81
F.3. IEEE 802.15.4a CSS	81

1. Overview

2. References

3. Definitions

4. Abbreviations

5. General Description

5.4 Functional Overview

5.4.4 Robustness

Change text as follows

The LR-WPAN employs various mechanisms to ensure robustness in the data transmission. The CSS and UWB PHYs, described in sections 6.5a and 6.8a respectively, have additional robustness over the direct sequence spread spectrum PHYs due to their wider bandwidths and their use of Forward Error Correction. The Chirp Spread Spectrum (CSS) PHY uses a spreading mechanism to provide approximately 14 MHz bandwidth. The Ultra Wide Band (UWB) PHY uses very short duration impulses to generate its approximately 500/1500 MHz bandwidth. Additional robustness enhancement mechanisms provided by the MAC are the CSMA-CA mechanism, frame acknowledgment, and data verification and are briefly discussed in 5.4.4.1 through 5.4.4.3. The mandatory mode for UWB devices does not utilize CSMA-CA since the randomness of the PSDU makes carrier sense not dependable; instead the mandatory mode for UWB uses the Aloha protocol; solely relying upon UWB's extreme bandwidth for robustness. As an option, a superimposed preamble can be emplaced into the UWB's PSDU to allow CSMA-CA to be used.

Insert the following sub-clause before 5.4.4.1

5.4.4.1a Aloha protocol

In the Aloha protocol a device transmits when it desires to transmit without sensing the medium or waiting for a specific time slot. The Aloha mechanism is appropriate for lightly loaded networks since the probability of collision is reasonably small if the probability of clear channel is sufficiently large. An undesirable property of Aloha is that for network loading greater than about 18% of the network capacity the network performance significantly declines due to collisions. Networks that are intended to be loaded greater than this loading typically resort to a CSMA-CA mechanism, deterministic, or other mechanisms.

Insert the following sub-clauses

5.4.7 Ranging

The UWB PHY as described in section 6.8a is specifically defined to allow precision ranging between UWB devices. This precision range information allows location awareness applications to determine the location of devices within the network. Information on methods of location awareness is included in Annex D1. Significant aspects of adding ranging to the 802.15.4 standard include adding a preamble that facilitates acquisition and precise timing, ranging information formats indicating the ranging results in a standardized manner for use by the application, and a figure of merit allowing the application the ability to determine the potential for error in the range information.

5.4.7.1 Ranging mechanisms

There are a number of different types of ranging mechanisms such as:

- Time-of-Arrival (TOA)
- Time-Difference-of-Arrival (TDOA)

- Signal Strength Ranging (SSR)
- Angle-of-Arrival (AOA)

It is not the intent of this standard to favor one mechanism over another, rather it is the intent to provide sufficient support in the PHY and MAC layers to allow an upper layer(s) to perform the appropriate ranging operation

5.4.7.2 Ranging accuracy

The ranging accuracy is affected by the bandwidth of the signal, the signal to noise ratio, and the magnitude of the line of sight component. This standard allows the user to select either the 500 MHz bandwidth or the optional 1500 MHz bandwidth. It should be noted that the larger bandwidth not only assists in accuracy due to the bandwidth itself but also due to the extra transmit power (due to regulatory limits on spectral density) resulting in higher signal to noise ratios.

5.4.7.3 Ranging privacy

The 802.15.4 standard has optional modes for security which include a high grade encryption algorithm. However since the detection of the preamble would allow a rogue device to determine range this standard has included an option to dither the preamble sufficiently to provide some protection against a rogue device.

6. PHY Specification

6.1 General requirements and definitions

Insert at end of bulleted list

-- Precision ranging

Insert after last paragraph

Further additions to the rates supported in IEEE Std 802.15.4:2003, two high data rate PHYs have been added. They are Chirp Spread Spectrum (CSS) in the 2.4GHz band UltraWideband (UWB) operating in the 3GHz to 10GHz band.

6.1.1 Operating frequency range

Change the 2450 row in table 1

2450 in column one becomes 2450 DS

Insert rows at the end of table 1

Table 1 – Frequency bands and data rates

PHY (MHz)	Frequency band (MHz)	Spreading parameters		Data parameters		
		Chip rate (kchips/s)	Modulation	Bit rate (kb/s)	Symbol rate (ksymbols/s)	Symbols
494 UWB	250-750	See table 1 {xref}				
2450 CSS	2400-2483.5			250		
				1000		
3000 UWB	3200-4693	see 6.8a. {xref}				
6000 UWB	5931.9-10304.25	See 6.8a. {xref}				

Insert a new sentence at the end of the paragraph Network formation...

Option frameworks for UWB PHYs are found in {xref}.

Change in the paragraph This standard ... the sentence

IEEE 802.15.4-REVb/D3 and IEEE 802.15.4- Amendment/D1 devices shall...

{ Add the references for regulatory for UWB and CSS for each region. Email sent to Patricia on 29 November with a request for content. }

6.1.2 Channel assignments

Change the first sentence

The introduction of the ~~“868/915 MHz band (optional) PSSS PHY specifications” and “868/915 MHz band (optional) O-QPSK PHY specifications”~~ several optional PHY types operating in several frequency bands results in

Insert a new paragraph at the end of this sub-clause.

For UWB and CSS PHYs the presence of both frequency band channels and sub-channels within frequency bands introduces an additional construction to the 32 bit channel bitmap for those PHYs. The lower 23 bits of the channel bit map will be such that the lower 23 bits are divided into two fields as defined in {xref} for UWB PHYs and {xref } for CSS PHYs.

6.1.2.1 Channel numbering

Insert a new sentence at the end of the last paragraph

An exception to this is the UWB PHY where specific mandatory and optional behaviors are defined.

Insert new sub-clauses

6.1.2.1a Channel numbering for CSS PHY

A total of 14 frequency channels, numbered 1 to 14, are available across the 2.4 GHz band. Different subsets of these frequency channels are available in different regions of the world. In North America and Europe 3 frequency channels can be selected such that the non-overlapping frequency bands are used.

Table 1 Center Frequencies of CSS

Frequency channel number	Frequency [MHz]
1	2412
2	2417
3	2422
4	2427
5	2432
6	2437
7	2442
8	2447
9	2452
10	2457
11	2462
12	2467
13	2472
14	2484

A channel frequency defines the center frequency of each band for CSS.

$F_c = 2412 + 5 \times (k-1)$ in megahertz, for $k = 1, 2, \dots, 13$

$F_c = 2484$ in megahertz, for $k = 14$

where k is the band number.

14 different frequency bands in combination with 4 different sub-chirp sequences form a set of $14 \times 4 = 56$ channels.

6.1.2.1b Channel numbering for UWB PHY

In the frequency range 3211 – 4693 MHz the channel numbering is as follows

$$f_c = 3458 + (k - 1) * 494$$

The UWB PHY admits 15 frequency bands as listed in {?}. A compliant device shall be capable of transmitting in channel 2 with a signal whose 3dB bandwidth is 494MHz. Transmission in all other frequency band is optional. However, if transmission in the frequency range 5931.9-10304.25 MHz is desired then a transmitter shall be capable of transmitting in channel 8.

Table {?} UWB PHY channel frequencies

Channel Number	Center frequency (MHz)	Band Width (3dB)	Mandatory/Optional
1	3458	494	Optional
2	3952	494	Mandatory
3	4446	494	Optional
4	3952	1482	Optional
5	6337.5	507	Optional
6	7098	507	Optional
7	7605	507	Optional
8	8112	507	Optional (Mandatory in High Band)
9	8619	507	Optional
10	9126	507	Optional
11	9633	507	Optional
12	10140	507	Optional
13	6591	1318.2	Optional
14	8112	1352	Optional
15	8961.75	1342.5	Optional

6.1.2.2 Channel pages

Insert rows before the last row (3-31) and change last row to 5-31 (binary to 00101) of Table 2.

Table 2 – Channel page and channel number

Channel page (decimal)	Channel page (binary) (b31,b30,b29,b28,b27)	Channel number(s) (decimal)	Channel number description
3	00011	See note 1 below	Channels for CSS PHY
4	00100	See note 2 below	Channels for UWB PHY

Insert the following after the table.

Note 1 : For CSS PHYs bits 0 – 13 are for frequency band, bits 14—17 sub-chirp sequence, and bit 18— data rate.

Note 2: For UWB PHYs the composition of the channel number field is defined in {xref – in 6.8a}

6.1.3 Minimum LIFS and SIFS periods

Insert rows in Table 3

Table 3 – Minimum LIFS and SIFS period

PHY	aMinSIFSPeriod	aMinLIFSPeriod	Units

2400-2483.5 MHz CSS	12	40	symbols
3100 – 10000 MHz	{?}	{?}	symbols

6.2 PHY Service Specifications

6.2.1. PHY Data Service

{The ranging and UWB PHY options (some of them) require per-packet primitive parameters to be added. What follows will be updated when the options are stable.}

6.2.1.1. PD-Data.request

6.2.1.1.1 Semantics of the Service Primitive

Insert additional parameters into the PD-DATA.request

The semantics of the PD-DATA.request primitive is as follows:

```
PD-DATA.request (
    psduLength,
    psdu,
    UWBPreambleType,
    UWBDataRate
)
```

Table 6 specifies the parameters for the PD-DATA.request primitive.

Insert additional rows into table 6

Table 6—PD-DATA.request parameters

Name	Type	Valid range	Description
UWBPreampType	Enumeration	table {xref}	The preamble type of the UWB PHY frame to be transmitted by the PHY entity.
UWBDataRate	Enumeration	table {xref}	The data rate of the UWB PHY frame to be transmitted by the PHY entity.

6.2.1.2 PD-Data.confirm

6.2.1.2.1 Semantics of the Service Primitive

The semantics of the PD-DATA.confirm primitive is as follows:

```
PD-DATA.confirm (
    status,
    Timestamp
)
```

Table 7 specifies the parameters for the PD-DATA.confirm primitive.

Table 7—PD-DATA.confirm parameters

Name	Type	Valid range	Description
Timestamp	Integer	0x000000-0xFFFFFFFF	Optional. The timestamp with high resolution (see 6.8.3.3){xref} of the PHY frame transmitted by the PHY entity. Implementation specific.

6.2.1.3 PD-Data.indication

6.2.1.3.1 Semantics of the Service Primitive

The semantics of the PD-DATA.indication primitive is as follows:

```

PD-DATA.indication (
    psduLength,
    psdu,
    ppduLinkQuality,
    UWBPreambleType,
    UWBDataRate,
    Timestamp
)
    
```

Table 8 specifies the parameters for the PD-DATA.indication primitive.

Name	Type	Valid range	Description
ppduLinkQuality	Bitmap	0x0000000-0xFFFFFFFF	The 8 LSBs represent the link quality (LQI) value measured during reception of the PPDU (see 6.9.8). Optional. The 24 MSBs represent the figure of merit information of a ranging operation (see 6.8.3.4).
UWBPreambleType	Enumeration	Table {xref}	The preamble type of the UWB PHY frame received by the PHY entity.
UWBDataRate	Enumeration	Table {xref}	The data rate of the UWB PHY frame to be transmitted by the PHY entity.
Timestamp	Integer	0x000000-0xFFFFFFFF	Optional. The timestamp with high resolution (see 6.8.3.3){xref} of the PHY frame received by the PHY entity. Implementation specific.

6.3 PPDU Format

Change second bullet to

-- A PHY header (PHR), which contains frame length information and rate and preamble information for UWB PHYs.

6.3.1 General packet format

Change the sentence to

The PPDU packet structure shall be formatted as illustrated in ~~figure~~ figures 16, table 4.1, and 16a.

Insert following figures after figure 16.

		Octets		
		2		variable
Preamble	SFD	Rate (see figure 16b)	Length	PSDU
SHR		PHR		PHY payload

Figure 16a – Format of the UWB PDU**Table 4.1 CSS PPDU format**

Data-rate	SHR		PHR	PSDU
	Preamble	SFD		
1 Mb/s	8 chirps	4 chirps	2 chirps	variable
250 kb/s (optional)	20 chirps	4 chirps	8 chirps	variable

Note: The preamble sequence includes the starting reference symbol which is required for differential transmission

6.3.1.1 Preamble field

Insert the following after the first paragraph

The preamble field for the CSS PHY is defined in 6.5a {xref}.
The preamble field for the UWB PHY is defined in 6.8a {xref}.

6.3.1.2 SFD field

Insert the following after the first paragraph

The CSS SFD should be a sequence which is reliably detectable (high detection probability, low false alarm probability, low miss probability) after the preamble sequence. The bit sequences defined in table 5 are such sequences. Different SFD sequences are defined for the two different data rates. A SFD sequence from table 5 shall be applied directly to both inputs (I and Q) of the QPSK Mapper as shown in Figure 1. A SFD sequence starts with bit 0.

Table 5 CSS SFD Sequence {xref}

Data-rate	bit (0:15)
1 Mb/s	-1 1 1 1 -1 1 -1 -1 1 -1 -1 1 1 1 -1 -1
250 kb/s (optional)	-1 1 1 1 1 -1 1 -1 -1 -1 1 -1 -1 -1 1 1

The SFD field for the UWB PHY is defined in 6.8a {xref}.

Change the title of figure 17

Figure 17—Format of the SFD field (except for PSSS, UWB, and CSS)

Insert the following sub clause

6.3.1.2a UWB rate field

The rate octet shall be format as shown in figure 16b. The relative enumeration of the data rate encoding field is shown in table 18a. Data rates are defined in 6.8a.1.

The preamble duration field is 4 bits in length and specifies the preamble duration. Table 21a summarizes the preamble duration. Preamble duration is defined, see 6.8a.2.

Bit 7	6	5	4	3	2	1	0
reserved	Preamble duration field (see figure 16xx){xref}				Data rate encoding field (see figure 16b){xref}		

Figure 16b –Data rate PHY header octet

The data rate field shall be encoded as shown in figure 16b.. All remaining possible enumerations not in tables 18a and 21 are reserved for future standards use.

Table 18a – Data rate field

PHY rate	Bit 2	Bit 1	Bit 0
Rate 1	0	0	0
Rate 2	0	0	1
Rate 3	0	1	0
Rate 4	0	1	1
Rate 5	1	0	0

Table 21—Preamble duration field

Preamble duration	Bit 6	Bit 5	Bit 4	Bit 3
Preamble 1	0	0	0	0
Preamble 2	0	0	0	1
Preamble 3	0	0	1	0
Preamble 4	0	0	1	1
Preamble 5	0	1	0	0
Preamble 6	0	1	0	1
Preamble 7	0	1	1	0
Preamble 8	0	1	1	1
Preamble 9	1	0	0	0

6.3.1.3 Frame length field

Change the first sentence

The frame length field is 7 bits in length (except for CSS PHY where it is 8 bits in length) and ...

6.4 PHY Constants and PIB attributes

6.4.1 PHY constants

Table 6 PHY constants

Constant	Description	Value
aMaxPHYPacketSize	The maximum PSDU size (in octets) the PHY shall be able to receive.	<u>255 for CSS PHY</u> <u>127 for all other PHY types</u>
aTurnaroundTime	TX-to-RX maximum turnaround time	<u>12 chirp symbol periods for CSS PHY</u> <u>12 symbol periods for all other PHY types</u>

6.4.2 PIB Attributes

Change *phyCCAMode* in table 23

Insert rows at the end of table 23

Table 23—PHY PIB attributes

Attribute	Identifier	Type	Range	Description
<i>phyCCAMode</i>	0x03	Integer	1-32	The CCA mode (see 6.9.9)
<i>phyRangingSupported</i> [†]	0x08	Boolean	TRUE or FALSE	This indicates whether the PHY sublayer supports the optional ranging features*.
<i>phyTxSyncSymbolOffset</i> [†]	0x09	Integer	0x000000-0xFFFFFFFF	Optional. The offset, measured in high resolution, between the symbol boundary at which the PLME captures the timestamp of each transmitted frame, and the onset of the first symbol past the SFD leaving the antenna.
<i>phyRxSyncSymbolOffset</i> [†]	0x0a	Integer	0x000000-0xFFFFFFFF	Optional. The offset, measured in high resolution, between the symbol boundary at which the PLME captures the timestamp of each received frame, and the onset of the first symbol past the SFD arriving on the antenna.
<i>phyPreambleSymbLength</i>	0x0b	Boolean	1 or 0	0 indicates preamble symbol length is 31, 1 indicates that length 127 symbol is used
<i>phyUWBDataRatesSupported</i> (read only)	0x0c	Bitmap	0x00-0x1f	A bit string that indicates the status (1= available, 0= unavailable) for each of the 5 valid data rates.
<i>phyUWBPreamblesSupported</i> (read only)	0x0d	Bitmap		
<i>phyCCAModesSupported</i> (read only)	0x0e	Bitmap		

Attribute	Identifier	Type	Range	Description
<i>phyUWB PulseShapesSupported(read only)</i>	0x0f	Bitmap		
<i>phyUWB CurrentPulseShape</i>	0x10	Bitmap		
<i>phyUWB PRFSupported(read only)</i>	0x11	Bitmap		
<i>phyUWB CurrentPRF</i>	0x12	Bitmap		

*optional PHY ranging features: to be listed

A code and a band combination define a channel. Networks operate on a single channel at a time. Thus the PHY's PIB for current channel is set to the agreed upon value and the PHY will only use that value.

Insert the following after 6.5

6.5a 2450 MHz PHY Chirp Spread Spectrum (CSS) PHY

The requirements for the 2450 MHz CSS PHY are specified in 6.5a.1 through 6.5a.5.

6.5a.1 Data rates

The data rate of the Chirp Spread Spectrum (2450MHz) PHY shall be 1 Mb/s. An additional data rate 250 kb/s shall be optional.

6.5a.2 Modulation and spreading

This PHY uses Chirp Spread Spectrum (CSS) techniques in combination with Differential Quadrature Phase Shift Keying and 8-ary or 64-ary Bi-Orthogonal Coding for 1 Mb/s data-rate or 250 kb/s data-rate, respectively. By using time alternating time-gaps in conjunction with sequences of chirp signals (sub-chirps) in different frequency sub-bands with different chirp directions, this CSS PHY provides sub-chirp sequence division as well as frequency division.

6.5a.2.1 Reference Modulator Diagram

The functional block diagram in Figure 1 is provided as a reference for specifying the 2450 MHz CSS PHY modulation for both 1 Mb/s and optional 250 kb/s. The number in each block refers to the sub-clause that describes that function. All binary data contained in the PHR and PSDU shall be encoded using the modulation shown in Figure 1.

2	000010	1 1 -1 -1 1 1 -1 -1 1 1 -1 -1 1 1 -1 -1 1 1 -1 -1 1 1 -1 -1
3	000011	1 -1 -1 1 1 -1 -1 1 1 -1 -1 1 1 -1 -1 1 1 -1 -1 1 1 -1 -1
4	000100	1 1 1 1 -1 -1 -1 -1 1 1 1 1 -1 -1 -1 -1 1 1 1 1 -1 -1 -1 -1
5	000101	1 -1 1 -1 -1 1 -1 1 1 -1 -1 -1 -1 1 1 -1 -1 -1 -1 1 1 -1 -1 -1 -1
6	000110	1 1 -1 -1 -1 -1 1 1 1 1 -1 -1 -1 -1 1 1 1 1 -1 -1 -1 -1 1 1
7	000111	1 -1 -1 1 -1 1 1 -1 -1 -1 -1 1 1 -1 -1 -1 -1 1 1 -1 -1 -1 1 1 -1
8	001000	1 1 1 1 1 1 1 1 -1 -1 -1 -1 -1 -1 -1 -1 1 1 1 1 1 1 1 1 -1 -1 -1 -1 -1 -1
9	001001	1 -1 1 -1 1 -1 1 -1 -1 -1 -1 1 -1 1 1 -1 -1 -1 -1 -1 -1 -1 1 1 -1 -1 -1 -1
10	001010	1 1 -1 -1 1 1 -1 -1 -1 -1 1 -1 -1 1 1 1 1 -1 -1 1 1 -1 -1 -1 1 1 -1 1 1
11	001011	1 -1 -1 1 1 -1 -1 -1 -1 1 1 -1 -1 1 1 -1 -1 1 1 -1 -1 -1 1 1 -1 -1 1 -1
12	001100	1 1 1 1 -1 -1 -1 -1 -1 -1 -1 1 1 1 1 1 1 1 -1 -1 -1 -1 -1 -1 -1 1 1 1 1
13	001101	1 -1 1 -1 -1 1 -1 1 -1 1 -1 1 1 -1 -1 -1 -1 -1 -1 -1 -1 -1 1 1 -1 1 -1 -1
14	001110	1 1 -1 -1 -1 -1 1 1 -1 -1 1 1 1 1 -1 -1 1 1 -1 -1 -1 1 1 -1 1 1 1 -1 -1
15	001111	1 -1 -1 1 -1 1 1 -1 -1 1 1 -1 -1 -1 -1 1 1 -1 -1 -1 1 1 -1 -1 1 -1 -1 1
16	010000	1 1 1 1 1 1 1 1 1 1 1 1 1 1 1 1 -1 -1 -1 -1 -1 -1 -1 -1 -1 -1 -1 -1 -1 -1
17	010001	1 -1 1 -1 1 -1 1 -1 1 -1 1 -1 1 -1 1 -1 -1 -1 -1 -1 -1 -1 1 1 -1 -1 -1 -1
18	010010	1 1 -1 -1 1 1 -1 -1 1 1 -1 -1 1 1 -1 -1 -1 1 1 -1 -1 1 1 -1 -1 -1 -1 1 1
19	010011	1 -1 -1 1 1 -1 -1 1 1 -1 -1 1 1 -1 -1 -1 1 1 -1 -1 1 1 -1 -1 1 1 -1 1 1 -1
20	010100	1 1 1 1 -1 -1 -1 -1 1 1 1 1 -1 -1 -1 -1 -1 -1 -1 1 1 1 -1 -1 -1 -1 1 1 1 1
21	010101	1 -1 1 -1 -1 1 -1 1 -1 1 -1 1 -1 1 -1 1 1 -1 -1 -1 -1 -1 1 1 -1 -1 -1 -1 -1
22	010110	1 1 -1 -1 -1 -1 1 1 1 1 -1 -1 -1 -1 1 1 -1 -1 -1 1 1 -1 -1 -1 1 1 1 -1 -1
23	010111	1 -1 -1 1 -1 1 1 -1 1 -1 -1 -1 1 1 -1 -1 1 1 -1 -1 -1 -1 1 1 -1 -1 -1 -1 -1
24	011000	1 1 1 1 1 1 1 1 -1 -1 -1 -1 -1 -1 -1 -1 -1 -1 -1 -1 1 1 1 1 1 1 1 1 1 1
25	011001	1 -1 1 -1 1 -1 1 -1 1 -1 1 -1 1 -1 1 -1 1 -1 1 -1 1 -1 1 1 -1 -1 -1 -1 -1
26	011010	1 1 -1 -1 1 1 -1 -1 -1 1 -1 -1 1 1 -1 -1 1 1 -1 -1 1 1 1 1 -1 -1 1 1 -1 -1
27	011011	1 -1 -1 1 1 -1 -1 -1 1 1 -1 -1 1 1 -1 -1 1 1 -1 -1 1 1 -1 -1 1 1 -1 -1 -1
28	011100	1 1 1 1 -1 -1 -1 -1 -1 -1 -1 1 1 1 1 -1 -1 -1 1 1 1 1 1 1 1 1 -1 -1 -1 -1
29	011101	1 -1 1 -1 -1 1 -1 1 -1 1 -1 1 -1 1 -1 1 1 -1 -1 1 -1 1 -1 1 -1 -1 -1 -1 -1
30	011110	1 1 -1 -1 -1 -1 1 1 -1 -1 1 1 1 1 -1 -1 -1 1 1 1 -1 -1 1 1 -1 -1 -1 -1 1 1
31	011111	1 -1 -1 1 -1 1 1 -1 -1 1 1 -1 -1 -1 -1 1 1 -1 -1 1 1 -1 -1 1 1 -1 -1 1 1 -1
32	100000	-1 -1
33	100001	-1 1 -1 1 -1 1 -1 1 -1 1 -1 1 -1 1 -1 1 -1 1 -1 1 -1 1 -1 1 -1 1 -1 1 -1 1
34	100010	-1 -1 1 1 -1 -1 1 1 -1 -1 1 1 -1 -1 1 1 -1 -1 1 1 -1 -1 1 1 -1 -1 1 1 -1 1
35	100011	-1 1 1 -1 -1 1 1 -1 -1 1 1 -1 -1 1 1 -1 -1 1 1 -1 -1 1 1 -1 -1 1 1 -1 1 -1
36	100100	-1 -1 -1 -1 1 1 1 1 -1 -1 -1 -1 1 1 1 1 -1 -1 -1 -1 1 1 1 1 -1 -1 -1 1 1 1 1
37	100101	-1 1 -1 1 1 -1 1 -1 1 -1 1 -1 1 -1 1 -1 1 1 -1 -1 -1 -1 1 1 -1 -1 -1 1 -1 -1
38	100110	-1 -1 1 1 1 1 -1 -1 -1 1 1 1 -1 -1 -1 1 1 1 -1 -1 -1 1 1 1 -1 -1 -1 1 1 -1 -1
39	100111	-1 1 1 -1 1 -1 -1 -1 1 1 -1 1 -1 -1 1 1 -1 1 -1 -1 -1 1 1 -1 -1 -1 1 1 -1 -1
40	101000	-1 -1 -1 -1 -1 -1 -1 1 1 1 1 1 1 1 -1 -1 -1 -1 -1 -1 -1 1 1 1 1 1 1 1 1 1 1
41	101001	-1 1 -1 1 -1 1 -1 1 1 -1 1 -1 1 -1 1 -1 1 -1 1 -1 1 -1 1 1 -1 1 -1 1 -1 1 -1
42	101010	-1 -1 1 1 -1 -1 1 1 1 1 -1 -1 1 1 -1 -1 -1 1 1 -1 -1 1 1 1 1 -1 -1 1 1 -1 -1
43	101011	-1 1 1 -1 -1 1 1 -1 1 -1 1 1 -1 1 -1 1 1 -1 -1 1 1 -1 -1 1 1 -1 -1 1 1 -1 -1
44	101100	-1 -1 -1 -1 1 1 1 1 1 1 1 1 -1 -1 -1 -1 -1 -1 -1 1 1 1 1 1 1 1 1 1 -1 -1 -1
45	101101	-1 1 -1 1 1 -1 1 -1 1 -1 1 -1 1 -1 1 -1 1 1 -1 -1 1 1 -1 1 -1 1 -1 -1 -1 -1
46	101110	-1 -1 1 1 1 1 -1 1 1 -1 -1 -1 1 1 -1 -1 1 1 1 1 -1 -1 1 1 -1 -1 -1 -1 1 1
47	101111	-1 1 1 -1 1 -1 -1 1 1 -1 -1 1 1 -1 1 1 -1 1 -1 1 -1 1 -1 1 -1 -1 1 1 -1 -1
48	110000	-1 -1 -1 -1 -1 -1 -1 -1 -1 -1 -1 -1 -1 -1 1 1 1 1 1 1 1 1 1 1 1 1 1 1 1 1 1
49	110001	-1 1 -1 1 -1 1 -1 1 -1 1 -1 1 -1 1 -1 1 -1 1 -1 1 -1 1 -1 1 -1 1 -1 1 -1 1 -1
50	110010	-1 -1 1 1 -1 -1 1 1 -1 -1 1 1 1 1 -1 -1 1 1 -1 -1 1 1 -1 -1 1 1 -1 -1 1 -1 -1
51	110011	-1 1 1 -1 -1 1 1 -1 -1 1 1 -1 1 1 -1 1 -1 1 -1 1 -1 1 -1 1 -1 -1 1 1 -1 -1
52	110100	-1 -1 -1 -1 1 1 1 1 -1 -1 -1 1 1 1 1 1 1 1 -1 -1 -1 1 1 1 1 -1 -1 -1 -1 -1 -1
53	110101	-1 1 -1 1 1 -1 1 -1 -1 1 1 -1 1 -1 1 -1 1 -1 -1 -1 1 1 -1 1 -1 -1 -1 -1 -1 -1

54	110110	-1 -1 1 1 1 1 -1 -1 -1 -1 1 1 1 1 -1 -1 1 1 1 1 -1 -1 -1 -1 1 1 1 1 -1 -1 -1 1 1
55	110111	-1 1 1 -1 1 -1 -1 1 -1 1 1 -1 1 -1 -1 1 1 -1 -1 1 1 -1 1 -1 1 -1 1 -1 1 -1 1 -1
56	111000	-1 -1 -1 -1 -1 -1 -1 1 1 1 1 1 1 1 1 1 1 1 1 1 1 1 -1 -1 -1 -1 -1 -1 -1 -1 -1
57	111001	-1 1 -1 1 -1 1 -1 1 1 -1 1 -1 1 -1 1 -1 1 -1 1 -1 1 -1 1 -1 1 -1 1 -1 1 -1 1
58	111010	-1 -1 1 1 -1 -1 1 1 1 1 -1 -1 1 1 -1 -1 1 1 -1 -1 1 1 -1 -1 -1 1 -1 -1 1 1
59	111011	-1 1 1 -1 -1 1 1 -1 1 -1 -1 1 1 -1 -1 1 1 -1 -1 1 1 -1 -1 1 1 -1 1 1 -1 1 1
60	111100	-1 -1 -1 -1 1 1 1 1 1 1 1 1 -1 -1 -1 -1 1 1 1 1 -1 -1 -1 -1 -1 -1 -1 1 1 1 1
61	111101	-1 1 -1 1 1 -1 1 -1 1 -1 -1 -1 1 1 -1 1 -1 -1 1 1 -1 1 -1 1 -1 1 -1 1 1 -1 1
62	111110	-1 -1 1 1 1 1 -1 -1 1 1 -1 -1 -1 1 1 1 1 -1 -1 -1 1 1 -1 -1 1 1 1 1 1 -1 -1
63	111111	-1 1 1 -1 1 -1 -1 1 1 -1 -1 1 1 1 1 -1 -1 1 1 -1 1 -1 1 -1 1 -1 1 -1 1 -1 1

6.5a.2.5 Parallel - to - Serial Converter (P/S) and QPSK Symbol Mapping

Each Bi-Orthogonal code **word** shall be converted to a serial chip sequence.

Each pair of I and Q chips shall be mapped onto a QPSK symbol as specified in Table 8.

Table 8 QPSK Mapping Table

QPSK Symbol Mapping		
Input chips (I _k , Q _k)	Magnitude	Phase (degree)
1, 1	1	45
-1, 1	1	135
1, -1	1	-45
-1, -1	1	-135

6.5a.2.6 Differential-QPSK (DQPSK) Coding

The stream of QPSK symbols shall be differentially encoded by using a differential encoder with 4 QPSK symbol feedback memories. (This means that the phase differences between QPSK symbol 1 and 5, 2 and 6, 3 and 7, 4 and 8 and so on are computed.)

6.5a.2.7 DQPSK - to - DQCSK modulation

The stream of DQPSK symbols shall be modulated onto the stream of sub-chirps which is generated by the CSK Generator.

6.5a.2.8 CSK Generator

The CSK Generator shall periodically generate one of the four defined sub-chirp sequences (chirp symbols) with the appropriate timing. Since each chirp symbol consists of four sub-chirps the sub-chirp rate is 4 times higher than the chirp symbol rate.

6.5a.3 Preamble

The preamble for 1Mb/s consists of 8 chirp symbols and the preamble for optional 250kb/s consists of 20 chirp symbols as specified in Table 9. The preamble sequence on table 9 should be applied directly to both I input and the Q input of QPSK Mapper as shown in Figure 1.

Table 9 Preamble Sequence

Data-rate	Preamble Sequence
1 Mb/s	ones(0:31)
250 kb/s	ones(0:79)

6.5a.4 Waveform and Sub-Chirp Sequences

Four individual chirp signals, here called *sub-chirps*, shall be concatenated to form a full chirp symbol (sub-chirp sequence) which occupies two adjacent frequency sub-bands. Four different sub-chirp sequences are defined. Each sub-chirp is weighted with a raised cosine window in the time domain

6.5a.4.1 Graphical presentation of chirp symbols (sub-chirp sequences)

Four different sequences of sub-chirp signals are available for use.

Figure 2 depicts the four different chirp symbols (sub-chirp sequences) as time frequency diagrams. It can be seen, that four sub-chirps which either have a linear down chirp characteristic or linear up chirp characteristic and a center frequency which has either a positive or a negative frequency offset are concatenated.

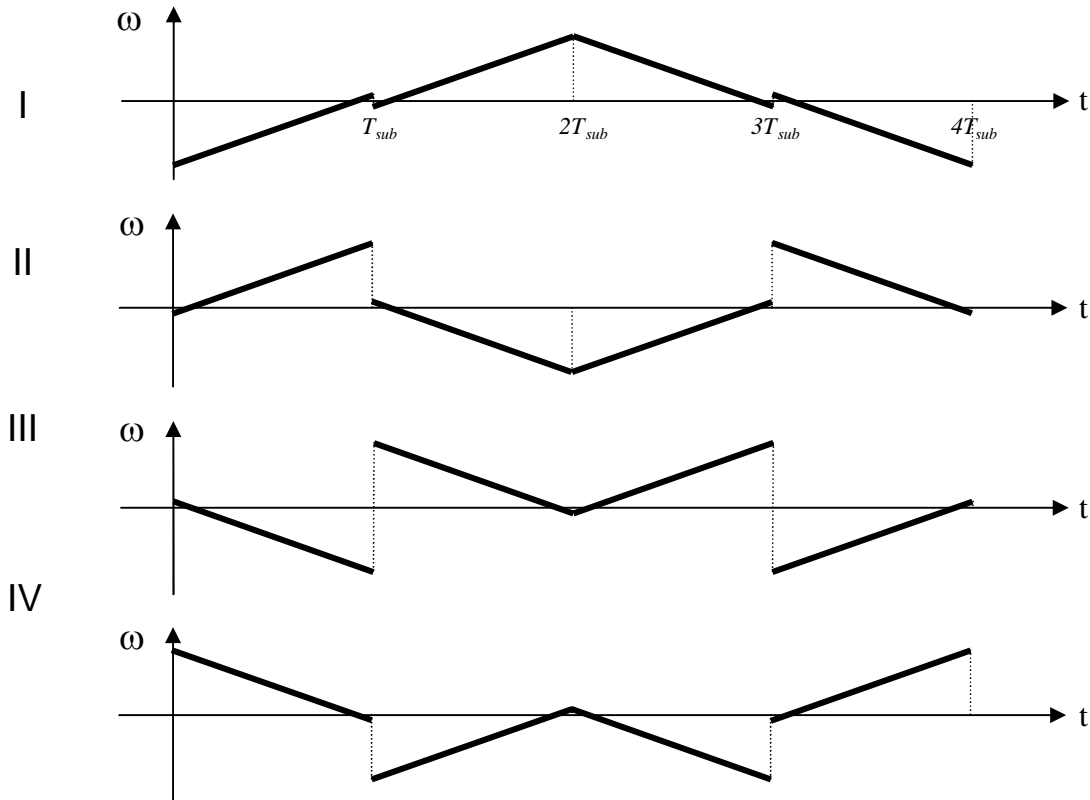

Figure 2 Four different combinations of sub-chirps

6.5a.4.2 Active usage of time gaps

In conjunction with the sub-chirp sequence different pairs of time-gaps are defined. These time gaps shall be applied alternatively between subsequent chirp symbols as shown in Figure 3. The values of the time gaps are calculated from the timing parameters specified in Table 2-(c).

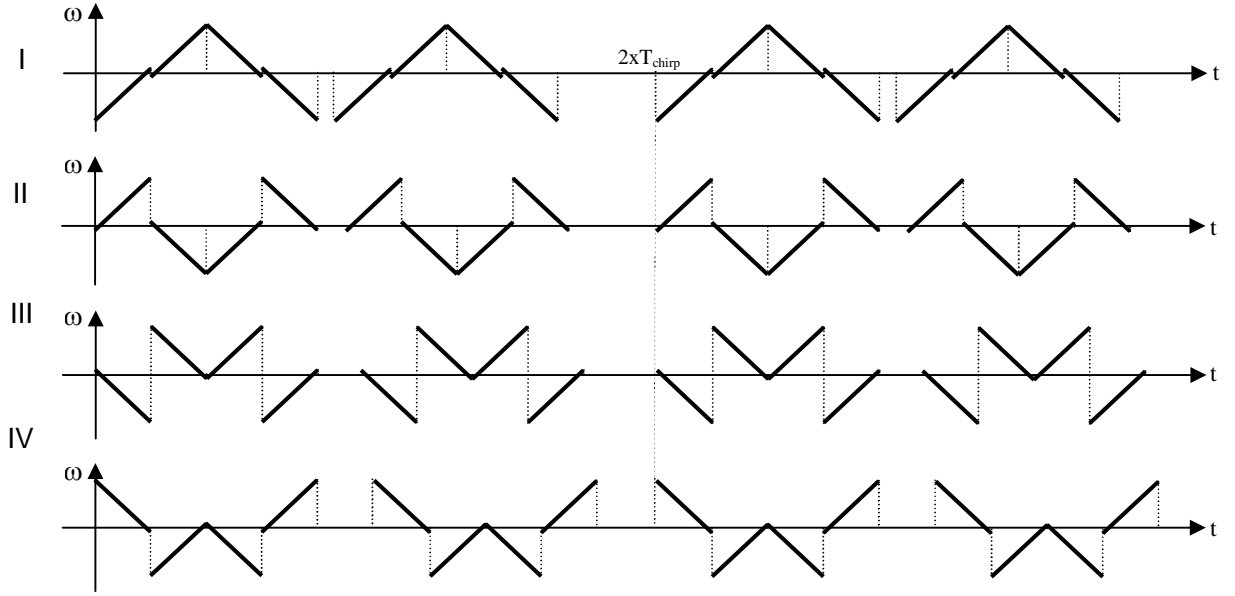

Figure 3 Four different time-gap pairs for four different sub chirp sequences

6.5a.4.3 Mathematical representation of the continuous time CSS Base-band signal

The mathematical representation of a continuous time-domain base-band signal $\tilde{s}^m(t)$ built of chirp symbols (sub-chirp sequences) as shown in Figure 2 with alternating time-gaps as shown in Figure 3 is given by equation (1).

$$\begin{aligned} \tilde{s}^m(t) &= \sum_{n=0}^{\infty} \tilde{s}^m(t, n) \\ &= \sum_{n=0}^{\infty} \sum_{k=1}^4 \tilde{c}_{n,k} \exp \left[j \left(\hat{\omega}_{k,m} + \frac{\mu}{2} \xi_{k,m} (t - T_{n,k,m}) \right) (t - T_{n,k,m}) \right] \cdot P_{RC} (t - T_{n,k,m}) \end{aligned} \quad (1)$$

Where $m = 1, 2, 3, 4$ (I, II, III, and IV in Figure 2) defines which of the four different possible chirp symbols (sub-chirp sequences) is used. $n = 0, 1, 2, \dots$ is the sequence number of the chirp symbols.

$\hat{\omega}_{k,m} = 2\pi \times f_{k,n}$ are the center frequencies of the sub-chirp signals. This value depends on m and $k=1, 2, 3, 4$ which defines the sub-chirp number in the sub-chirp sequence.

$$T_{n,k,m} = \left(k + \frac{1}{2} \right) T_{sub} + nT_{chirp} - \left(1 - (-1)^n \right) \tau_m \quad (2)$$

$T_{n,k,m}$ defines the starting time of the actual sub-chirp signal to be generated. It is determined by T_{chirp} which is the duration of a chirp symbol and by T_{sub} which is the duration of a sub chirp signal.

$T_{n,k,m}$ further depends on n, k and m .

The constant μ defines the characteristics of the sub chirp signal. A value of

$$\mu = 2\pi \times 7.3158 \times 10^{12} [\text{rad} / \text{sec}^2] \text{ shall be used.}$$

The constant τ_m is either added or subtracted and thus determines the time-gap which was applied before the actual chirp symbol as shown in Figure 3. Since the choice of one of the four possible sub-chirp sequences also determines the pair of time-gaps to be applied alternatively, τ_m is dependent on m .

Table 10 shows the values for the sub-band center frequencies, the sub-chirp directions, and the timing parameters in equation (1).

Table 10 Numerical Parameters in the Equation (1)

(a) Sub-band center frequencies, $f_{k,m}$ [MHz]				
m\k	1	2	3	4
1	fc-3.15	fc+3.15	fc+3.15	fc-3.15
2	fc+3.15	fc-3.15	fc-3.15	fc+3.15
3	fc-3.15	fc+3.15	fc+3.15	fc-3.15
4	fc+3.15	fc-3.15	fc-3.15	fc+3.15

(b) Sub-chirp directions, $\xi_{k,m}$				
m\k	1	2	3	4
1	+1	+1	-1	-1
2	+1	-1	+1	-1
3	-1	-1	+1	+1
4	-1	+1	-1	+1

(c) Timing parameters	
T_{chirp}	6 us
T_{sub}	1.1875 us
τ_1	468.75 ns
τ_2	312.5 ns
τ_3	156.25 ns
τ_4	0 ns

6.5a.4.4 the Raised Cosine Window for Chirp Pulse Shaping

The Raised-cosine time-window described by equation (3) shall be used to shape the sub-chirp. The Raised Cosine Window $P_{RC}(t)$ is applied to every sub-chirp signal in the time domain.

$$P_{RC}(t) = \begin{cases} 1 & |t| \leq \frac{(1-\alpha) T_{sub}}{(1+\alpha) 2} \\ \frac{1}{2} \left[1 + \cos \left(\frac{(1+\alpha) \pi}{\alpha T_{sub}} \left(|t| - \frac{(1-\alpha) T_{sub}}{(1+\alpha) 2} \right) \right) \right] & \frac{(1-\alpha) T_{sub}}{(1+\alpha) 2} < |t| \leq \frac{T_{sub}}{2} \\ 0 & |t| > \frac{T_{sub}}{2} \end{cases} \quad (3)$$

where $\alpha = 0.25$

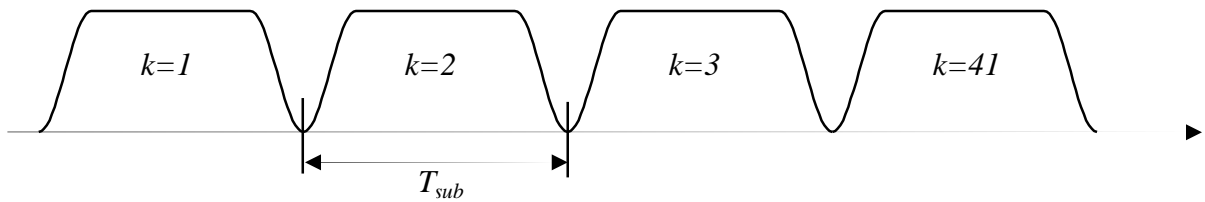

Figure 4 Sub-chirp Time-domain Pulse Shaping

6.5a.4.5 Sub-Chirp transmission order

During each chirp symbol period the sub-chirp 1 ($k=1$), is transmitted first and the most significant chirp, sub-chirp 4 ($k=4$) is transmitted last.

6.5a.5 2450 MHz band radio specification

In addition to meeting regional regulatory requirements, devices operating in the 2450 MHz band shall also meet the radio requirements in 6.5a.5.1 through 6.5a.5.4.

6.5a.5.1 Transmit power spectral density (PSD) mask

The transmitted spectral power density shall be within the relative limits specified in the template shown in Figure 5. The average spectral power shall be measured using a 100 kHz resolution bandwidth. For the relative limit, the reference level shall be the highest average spectral power measured within ± 11 MHz of the carrier frequency.

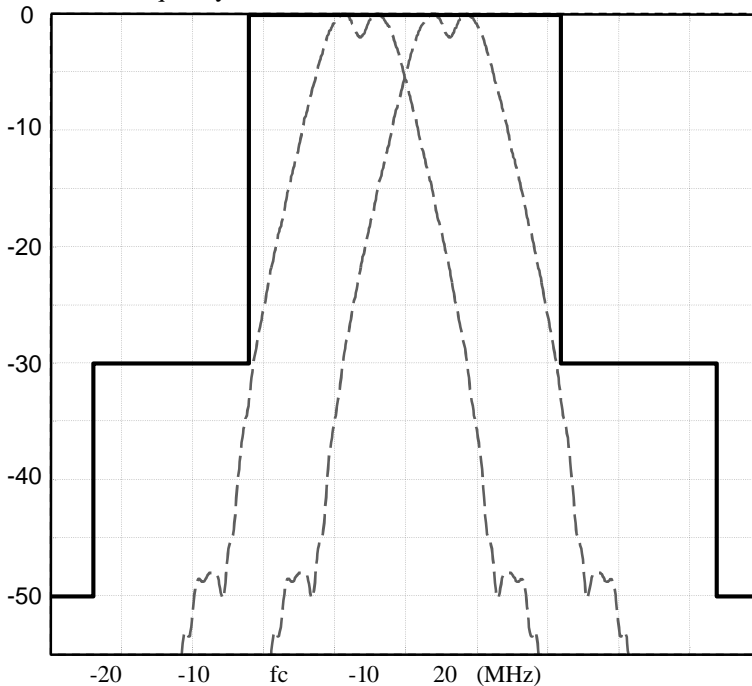

Figure 5 Transmit power spectral density mask

6.5a.5.2 Symbol rate

The 2450 MHz PHY DQCSK symbol rate shall be 166.667 ks/s ($1/6$ Ms/s) ± 40 ppm.

6.5a.5.3 Receiver sensitivity

Under the conditions specified in 6.1.6 of 15.4.2003, a compliant device shall be capable of achieving a sensitivity of -80 dBm or better.

6.5a.5.4 Receiver Jamming Resistance (Informative)

Table 11 gives jamming resistance levels which can be realized with modest effort. An adjacent channel is defined to have a center frequency offset of 20 MHz. An alternate channel is defined to have a center frequency offset of 40 MHz

The adjacent channel rejection shall be measured as follows. The desired signal shall be a compliant 2450 MHz IEEE 802.15.4a signal of pseudo-random data. The desired signal is input to the receiver at a level 3 dB above the maximum allowed receiver sensitivity given in 6.5a.5.3.

In the adjacent or the alternate channel, an IEEE 802.15.4a signal of the same or a different sub chirp sequence as the victim device is input at the relative level specified in Table 11. The test shall be performed for only one interfering signal at a time. The receiver shall meet the error rate criteria defined in 6.1.6 of 15.4-2003 under these conditions.

Table 11 Minimum receiver jamming resistance levels for 2450 MHz CSS PHY

Data-rate	Adjacent Channel Rejection (20 MHz offset)	Alternate Channel Rejection (40 MHz offset)
1 Mb/s	26 dB	42 dB
250 kb/s (optional)	30 dB	46 dB

Insert the following after 6.8

6.8a. 3100 to 10000MHz PHY Ultra Wide Band (UWB)

{Add text giving general overview of UWB Phy Features}

6.8a.1 Data Rates

The data rate of the UWB PHY is dependent upon the channel in which the PHY is operating. The table below depicts the supported data rates in each UWB PHY channel. In each channel at least one data rate shall be supported if the PHY is capable of transmitting in said channel as per the *phyChannelsSupported* parameter in the PIB.

Table 1 Mandatory and optional data rates in each channel

Channel Number	Data Rate (Mbps)	Mandatory/Optional (M/O)
{1,2,3,4}	0.105	O
	0.842	M
	3.370	O
	13.477	O
	26.954	O
{5,6, ... 12}	0.108	O
	0.864	M
	3.458	O
	13.831	O
	27.663	O
{13}	0.094	O
	0.749	M
	3.997	O
	11.987	O

	23.975	O
{14}	0.096	O
	0.768	M
	3.074	O
	12.295	O
	24.590	O
{15}	0.095	O
	0.763	M
	3.057	O
	12.209	O
	24.417	O

6.8a.2 Ranging/Acquisition Symbol (Preamble)

The preamble field is used by the transceiver to obtain chip and symbol synchronization with an incoming message and to track signal leading edge for ranging. The available options for the preamble length are shown in Table 1.

Table 1 Preamble field length

Code Length	Preamble Index	Mandatory /Optional	Mean PRF (MHz)	Preamble Length	Duration
31	1	M	15.875	64 symbols	124.976 uS
31	2	M	15.875	256 symbols	500 uS
31	3	M	15.875	1024 symbols	2 mS
31	4	M	3.96875	64 symbols	500 uS
31	5	M	3.96875	256 symbols	2 mS
31	6	M	3.96875	1024 symbols	7.998 mS
127	7	O	127.48	64 symbols	32.907 uS
127	8	O	127.48	256 symbols	131.627 uS
127	9	O	127.48	1024 symbols	526.51 uS

A code from Table 1 is used as a ranging/acquisition code S_i . The code can be selected from length 31 or length 127 Ternary codes. Length 31 Ternary codes are given in Table Z1. These are the six codes with the best cross-correlation of the 12 possible codes with perfect periodic auto-correlation. Out of seventy two length-127-Ternary-codes, listed in Table Z2 are the 26 codes with perfect periodic autocorrelation and best cross-correlation properties.

Table Z1 Length 31 Ternary codes

Index	ID	Sequence
1	S_1	+0++000-+-++00++0+00-0000-0+0--
2	S_2	+ -0+0+00+000+0++--0-+00-++0000
3	S_3	000+-00-00-+++0+-+000+0-0++0-0
4	S_4	0+0000-00-0+-00+++--000-+0+++0-
5	S_5	+0+-0+0+000-++0+-+--00+00++0000
6	S_6	000+00-0-0++0000--+00-+0++-++0+

Table Z2 Length 127 Ternary codes

Index	ID	Sequence
1	S_7	00000-0-0+0+0+00-00-0+00---+00-000-+0-0-0000++++++0+--+0+0-+--0+000+0+-00-0+--+000+000000+00-+0+000+--00+++0-0+--0000-00++
2	S_8	-0++0-+00-00-000+--+0000-0+--+00+0+0+--00+-0-000-00-++000-0+0000--00000-

		000000++++-0+0+0-00-+00+++0--0+00-0+000+++0+++0--0
3	S_9	+0-000++++-00-000000-0+00000++0-0000+00--000--0-00+00-0+--+0++0- ++00++0+00-0+0++0-0++++-0+++0000-000+000+0+00--00-+++0+0
4	S_{10}	0+-0+0+000+--+0000++000+0+00++000000++0-0--0-00+0-0+0++0+-- 00+0000+000+00-00+--+0-0+00000-0-++00--0---++0+0-00+0-+000-+0
5	S_{11}	0+--+000-+-0--0+0-+-+0+00+0+-00+0-00+++00-000++000+0+++0000-0000- +0+00000+--+0+0+000000-0+0-+0----00++0+0+0-0+000+00-00++0
6	S_{12}	-+000000++0-0+--0+00-0-0+0+0+++00+0000-000+00-00--++0+0+00000-0-+++00-- +0-+--+--0-+00-0+000-00++0+0+000+--+0000+++000-0+00

The preamble consists of repetitions of the selected code S_i . The ranging preamble should be transmitted in one of the forms given in Figure Z1.

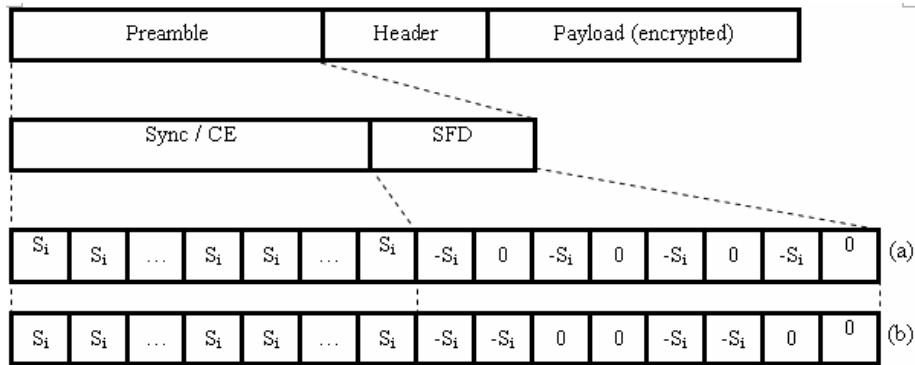

The S_i indicates the selected code with corresponding index i . Sync / CE is the combined synchronization frame and channel estimation sequence. SFD is the synchronization frame delimiter (a) Normal preamble (b) Preamble for 128kps.

Figure Z1 Illustration of synchronization part of ranging packet preamble.

6.8a.2.1 Extension of Preamble for optional CCA modes

To enable CCA of impulse UWB signal at any time, we introduce regular structure into the data portion of frame by interleaving preamble segments in the PSDU segments in time domain. The inserted preamble segments serve as regular CCA structure of the frame.

Figure CS-1 shows the frame structure which supports optional CCA modes (insert correct mode number). The PSDU part of frame originates from the MAC sublayer (5.4.3). After adding SHR and PHR at the beginning of PSDU, the PHY layer of transmitter regularly inserts preamble segments into the PSDU. Therefore the PSDU segments are interleaved by preamble segments alternatively. Each preamble segment consists of $numPreSegSym$ preamble symbols. Each PSDU segments consists of $numPSDUBit$ PSDU bits. The PSDU shall be ended with a preamble segment.

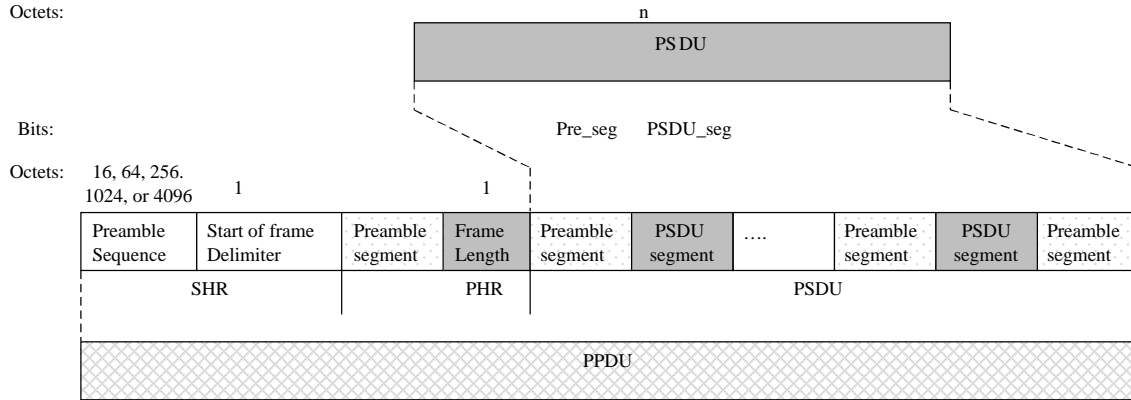

Fig.CS-1 Schematic view of frame structure which support optional CCA modes

The modulation of inserted preamble segments shall use mandatory data rate in the channel as well as the average PRF as set by the PAN coordinator. In addition, the inserted preamble code shall be the same as that of the regular frame preamble. The time interval between neighbour inserted preamble segments is computed as per mandatory data rate within current channel (see 6.8a.1). The PHY layers shall guarantee the constant time interval no matter which optional data rate is used.

The PHY PIB attribute *phyCCAMode* (see 6.4) shall indicate the appropriate optional CCA mode. Figure CS-2 shows the constant CCA detection window shall be equal to *numCCAWin*. Wherever the CCA detection window starts, either from the regular preamble or from the data portion in a frame, the CCA detectors shall find at least *numPreSeg*numPreSegSym* preamble symbols in the CCA detection window.¹

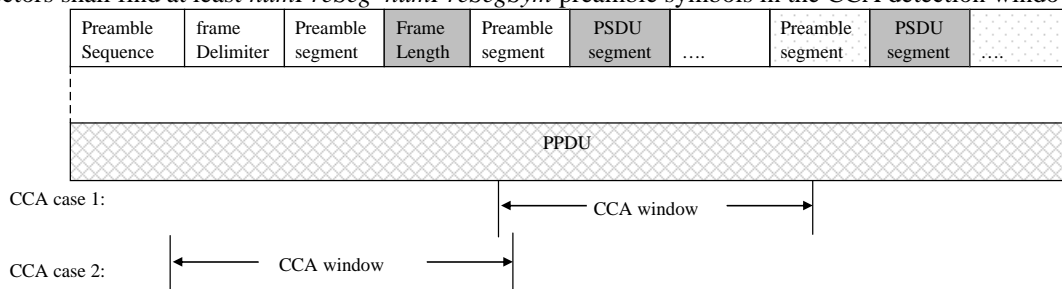

Fig.CS-2 CCA detection window

The frame structures shall only be applied to data frame and MAC frame in the CAP when the PHY PIB attribute *phyCCAMode* (see 6.4) is set to the optional CCA mode. The frame structures shall not applied to

- all frames when PHY PIB attribute *phyCCAMode* (see 6.4) is set to mandatory ALOHA mode;
- data frame in the CFP;
- beacon frame and acknowledgement frame².

If the PLME-CCA.request primitive is received by the PHY during reception of a PPDU, CCA shall report a busy medium. Otherwise, an idle medium shall be reported.

When receiving the frame structure, the PHY layer of the destined device simply skips or discards the inserted preamble segments. Only the de-spread PSDU is passed to the MAC.

¹ We are waiting for input of typical preamble length and data portion to decide the optimal value of *numPreSeg*, *numPreSegSym*, and *numCCAWin*.

² In the beacon frame, only the mandatory features can be used. The ACK frame does not need to be CCA enabled because there are two times of CCA in the CSMA-CA algorithm.

6.8a.3 Waveform, Pulse Shape, and Chipping Rates

The UWB PHY uses an impulse radio based signaling scheme in which each information bearing symbol is represented by a sequence/burst of short time duration (hence large bandwidth) pulses. The duration of an individual pulse is nominally considered to be the length of a chip. A UWB PHY compliant device shall be capable of transmitting pulses at a rate of 494 MHz. This is equivalent to a chip duration of 2.02429 ns or a chipping rate of 494MHz.

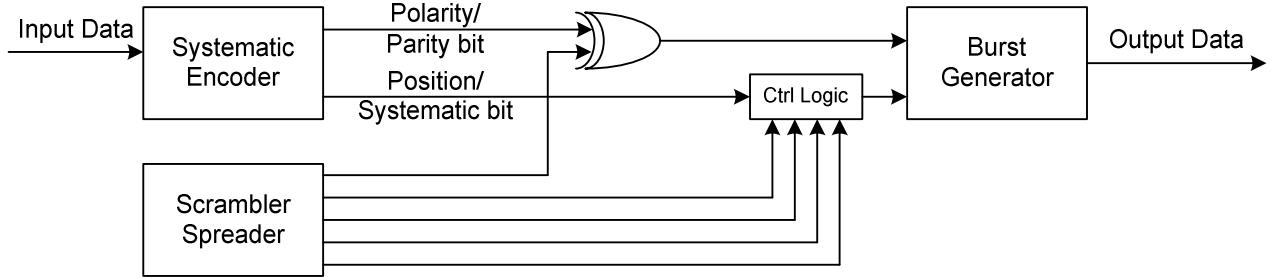

Figure 1 Reference Modulator (After FEC encoding)

As the UWB PHY is required to support both coherent and non coherent receivers the modulation format chosen is a combination of both Pulse Position Modulation (PPM) and Binary Phase Shift Keying (BPSK). Nominally, a UWB PHY symbol is capable of carrying two bits of information one bit is used to determine the position of a burst of pulses while an additional bit is used to modulate the phase (polarity) of this same burst. { **Error! Reference source not found.** } is provided as a reference for specifying the processing of coded symbols and their subsequent conversion to an analog waveform. Each block is described in more detail in the following subsections of this clause.

6.8a.3.1 Structure of a UWB PHY symbol

Figure 2 a depicts the structure and timing of a UWB PHY symbol assuming the mandatory data rate of 1 Mbps. Each symbol shall consist of an integer number of chips which have duration of 2.02429 ns. Several consecutive chips are grouped together to form a burst. And the location of the burst in either the first half or second half of the symbol indicates one bit of information. Additionally, the phase of the burst is used to indicate a second bit of information. For a given symbol duration, T_{sym} the number of chips each in each symbol is

$$N_c = \lfloor T_s / 2.0429 \rfloor \tag{1}$$

Where $\lfloor \rfloor$ indicates a floor operation. A burst duration, T_{burst} , is related to the chip duration, T_c , and N_c and by

$$T_{burst} = N_b * T_c \tag{2}$$

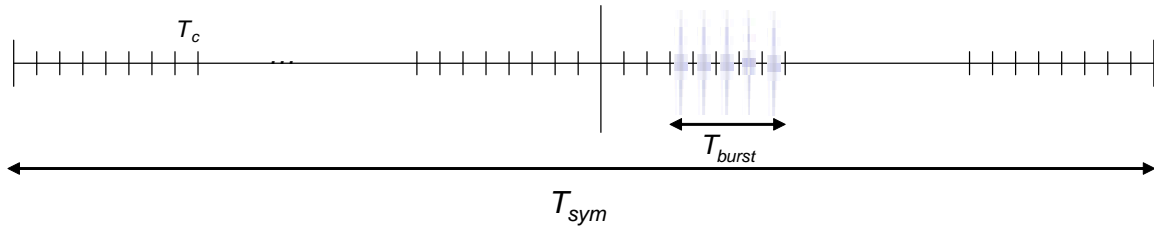

Figure 2 UWB PHY Symbol Timing

In addition to the modulation of data the UWB PHY symbol provides for some multi-user access interference rejection in the form of time hopping. Since each symbol contains a single burst of pulses and the burst length is typically much shorter than the duration of the symbol the location of the pulse within each burst can be varied from on a symbol to symbol basis according to a time hopping code. This is part of the functionality provided by the “Scrambler and Burst Position Hopping” block as depicted in Error!

Reference source not found.
 {there is a reference source not found error}

6.8a.3.2 UWB PHY Symbol Timing Details

The UWB PHY symbol may be expressed using the following equation

$$x^{(k)}(t) = \sum_{j=1}^{N_{burst}} g_1^{(k)} s_j p\left(t - g_0^{(k)} T_{PPM} - jT_c - h^{(k)} T_{burst}\right) \quad 3$$

In the above equation the $x^{(k)}(t)$ is the waveform of the k^{th} information bearing symbol, g_0 and g_1 are the modulation symbols obtained from a mapping of the coded bits, $s_j \{j = 0, 1, \dots, N_{burst} - 1\}$, is the scrambling sequence and takes the possible values $\{-1 \text{ or } 1\}$, $p(t)$ is the transmitted pulse shape at the input to the antenna, T_{PPM} is the duration of the binary pulse position modulation time slot. The hopping sequence $h^{(k)}$, provides suppression of multiuser interference and the scrambling sequence, s_j , provides additional interference suppression among coherent receivers as well as spectral smoothing of the transmitted waveform. The UWB PHY shall support two average Pulse Repetition Frequencies (PRF). Namely 15.4375MHz and 3.859375MHz. These PRFs in addition to the data rate, modulation and coding rate determines the overall timing of a UWB PHY symbol. The tables below call out the numerical values of the UWB PHY symbol for the various channels and preamble pulse repetition frequencies.

Table 2 UWB PHY Symbol Timing Parameters, Length 31 preamble

Channel Number	Pulses Burst N_{burst}	Peak PRF MHz (during modulation)	Peak PRF Preamble (MHz)	Mean PRF Preamble (MHz)	Channel Data Rate (Mbps)	Mean PRF during modulation (MHz)	Burst Duration, T_{burst} (ns)	Symbol Duration (us)	Symbol Rate (MHz)	Chip Duration, T_c (ns)	PPM duration, T_{PPM} (us)	# hopping slots, N_{slot}
{1,2,3}	512	494	123.5	62.236	0.105	61.750	1036.437	8.291	0.121	2.024	4.146	4
{1,2,3}	64	494	123.5	62.236	0.842	61.750	129.555	1.036	0.965	2.024	0.518	4
{1,2,3}	8	494	123.5	62.236	6.739	61.750	16.194	0.130	7.719	2.024	0.065	4
{1,2,3}	4	494	123.5	62.236	13.477	61.750	8.097	0.065	15.438	2.024	0.032	4
{1,2,3}	2	494	123.5	62.236	26.954	61.750	4.049	0.032	30.875	2.024	0.016	4
{4}	512	494	123.5	62.236	0.105	61.750	1036.437	8.291	0.121	2.024	4.146	4
{4}	64	494	123.5	62.236	0.842	61.750	129.555	1.036	0.965	2.024	0.518	4
{4}	8	494	123.5	62.236	6.739	61.750	16.194	0.130	7.719	2.024	0.065	4
{4}	4	494	123.5	62.236	13.477	61.750	8.097	0.065	15.438	2.024	0.032	4
{4}	2	494	123.5	62.236	26.954	61.750	4.049	0.032	30.875	2.024	0.016	4
{5,.....,12}	512	507	126.75	63.874	0.108	63.375	1009.862	8.079	0.124	1.972	4.039	4
{5,.....,12}	64	507	126.75	63.874	0.864	63.375	126.233	1.010	0.990	1.972	0.505	4
{5,.....,12}	8	507	126.75	63.874	6.916	63.375	15.779	0.126	7.922	1.972	0.063	4
{5,.....,12}	4	507	126.75	63.874	13.832	63.375	7.890	0.063	15.844	1.972	0.032	4
{5,.....,12}	2	507	126.75	63.874	27.664	63.375	3.945	0.032	31.688	1.972	0.016	4
{13}	512	439.4	109.85	55.357	0.094	54.925	1165.225	9.322	0.107	2.276	4.661	4
{13}	64	439.4	109.85	55.357	0.749	54.925	145.653	1.165	0.858	2.276	0.583	4
{13}	8	439.4	109.85	55.357	5.994	54.925	18.207	0.146	6.866	2.276	0.073	4
{13}	4	439.4	109.85	55.357	11.988	54.925	9.103	0.073	13.731	2.276	0.036	4
{13}	2	439.4	109.85	55.357	23.975	54.925	4.552	0.036	27.463	2.276	0.018	4
{14}	512	450.6666667	112.6666667	56.777	0.096	56.333	1136.095	9.089	0.110	2.219	4.544	4
{14}	64	450.6666667	112.6666667	56.777	0.768	56.333	142.012	1.136	0.880	2.219	0.568	4
{14}	8	450.6666667	112.6666667	56.777	6.147	56.333	17.751	0.142	7.042	2.219	0.071	4
{14}	4	450.6666667	112.6666667	56.777	12.295	56.333	8.876	0.071	14.083	2.219	0.036	4
{14}	2	450.6666667	112.6666667	56.777	24.590	56.333	4.438	0.036	28.167	2.219	0.018	4
{15}	512	447.5	111.875	56.378	0.095	55.938	1144.134	9.153	0.109	2.235	4.577	4
{15}	64	447.5	111.875	56.378	0.763	55.938	143.017	1.144	0.874	2.235	0.572	4
{15}	8	447.5	111.875	56.378	6.104	55.938	17.877	0.143	6.992	2.235	0.072	4
{15}	4	447.5	111.875	56.378	12.209	55.938	8.939	0.072	13.984	2.235	0.036	4
{15}	2	447.5	111.875	56.378	24.417	55.938	4.469	0.036	27.969	2.235	0.018	4

The additional optional channels shown in table 2 require different preamble PRFs that depend on the 3dB bandwidth. The pulse width and burst duration and other symbol timing parameters as specified in the following tables.

Table 3a UWB PHY Symbol Timing Parameters, Length 31 preamble Upper UWB Channels

Channel Number	Pulses Burst N_{burst}	Peak PRF MHz (during modulation)	Peak PRF Preamble (MHz)	Mean PRF Preamble (MHz)	Channel Data Rate (Mbps)	Mean PRF during modulation (MHz)	Burst Duration, T_{burst} (ns)	Symbol Rate (MHz)	Chips Per Symbol	Chip Duration, T_c (ns)	PPM duration, T_{PPM} (us)	# hopping slots, N_{slot}
{5,.....,12}	128	507	31.6875	16.355	0.108	15.844	252.465	0.124	4096	1.972	4.039	16
{5,.....,12}	32	507	7.921875	4.089	0.108	3.961	63.116	0.124	4096	1.972	4.039	64
{5,.....,12}	16	507	31.6875	16.355	0.864	15.844	31.558	0.990	512	1.972	0.505	16
{5,.....,12}	4	507	7.921875	4.089	0.864	3.961	7.890	0.990	512	1.972	0.505	64
{5,.....,12}	2	507	31.6875	16.355	6.916	15.844	3.945	7.922	64	1.972	0.063	16
{5,.....,12}	0.5	507	7.921875	4.089	6.916	3.961	0.986	7.922	64	1.972	0.063	64
{5,.....,12}	1	507	31.6875	16.355	13.832	15.844	1.972	15.844	32	1.972	0.032	16
{5,.....,12}	0.25	507	7.921875	4.089	13.832	3.961	0.493	15.844	32	1.972	0.032	64
{5,.....,12}	0.5	507	31.6875	16.355	27.664	15.844	0.986	31.688	16	1.972	0.016	16
{5,.....,12}	0.125	507	7.921875	4.089	27.664	3.961	0.247	31.688	16	1.972	0.016	64

Table 4b UWB PHY Symbol Timing Parameters, Length 31 preamble Upper UWB Channels

Channel Number	Pulses Burst N_{burst}	Peak PRF MHz (during modulation)	Peak PRF Preamble (MHz)	Mean PRF Preamble (MHz)	Channel Data Rate (Mbps)	Mean PRF during modulation (MHz)	Burst Duration, T_{burst} (ns)	Symbol Rate (MHz)	Chips Per Symbol	Chip Duration, T_c (ns)	PPM duration, T_{PPM} (us)	# hopping slots, N_{slot}
{13}	128	439.4	27.4625	14.174	0.094	13.731	291.306	0.107	4096	2.276	4.661	16
{13}	32	439.4	6.865625	3.544	0.094	3.433	72.827	0.107	4096	2.276	4.661	64
{13}	16	439.4	27.4625	14.174	0.749	13.731	36.413	0.858	512	2.276	0.583	16
{13}	4	439.4	6.865625	3.544	0.749	3.433	9.103	0.858	512	2.276	0.583	64
{13}	2	439.4	27.4625	14.174	5.994	13.731	4.552	6.866	64	2.276	0.073	16
{13}	0.5	439.4	6.865625	3.544	5.994	3.433	1.138	6.866	64	2.276	0.073	64
{13}	1	439.4	27.4625	14.174	11.988	13.731	2.276	13.731	32	2.276	0.036	16
{13}	0.25	439.4	6.865625	3.544	11.988	3.433	0.569	13.731	32	2.276	0.036	64
{13}	0.5	439.4	27.4625	14.174	23.975	13.731	1.138	27.463	16	2.276	0.018	16
{13}	0.125	439.4	6.865625	3.544	23.975	3.433	0.284	27.463	16	2.276	0.018	64

Table 5c UWB PHY Symbol Timing Parameters, Length 31 preamble Upper UWB Channels

Channel Number	Pulses Burst N_{burst}	Peak PRF MHz (during modulation)	Peak PRF Preamble (MHz)	Mean PRF Preamble (MHz)	Channel Data Rate (Mbps)	Mean PRF during modulation (MHz)	Burst Duration, T_{burst} (ns)	Symbol Rate (MHz)	Chips Per Symbol	Chip Duration, T_c (ns)	PPM duration, T_{PPM} (us)	# hopping slots, N_{slot}
{14}	128	450.666667	28.166667	14.538	0.096	14.083	284.024	0.110	4096	2.219	4.544	16
{14}	32	450.666667	7.0416667	3.634	0.096	3.521	71.006	0.110	4096	2.219	4.544	64
{14}	16	450.666667	28.166667	14.538	0.768	14.083	35.503	0.880	512	2.219	0.568	16
{14}	4	450.666667	7.0416667	3.634	0.768	3.521	8.876	0.880	512	2.219	0.568	64
{14}	2	450.666667	28.166667	14.538	6.147	14.083	4.438	7.042	64	2.219	0.071	16
{14}	0.5	450.666667	7.0416667	3.634	6.147	3.521	1.109	7.042	64	2.219	0.071	64
{14}	1	450.666667	28.166667	14.538	12.295	14.083	2.219	14.083	32	2.219	0.036	16
{14}	0.25	450.666667	7.0416667	3.634	12.295	3.521	0.555	14.083	32	2.219	0.036	64
{14}	0.5	450.666667	28.166667	14.538	24.590	14.083	1.109	28.167	16	2.219	0.018	16
{14}	0.125	450.666667	7.0416667	3.634	24.590	3.521	0.277	28.167	16	2.219	0.018	64

Table 6d UWB PHY Symbol Timing Parameters, Length 31 preamble Upper UWB Channels

Channel Number	Pulses Burst N_{burst}	Peak PRF MHz (during modulation)	Peak PRF Preamble (MHz)	Mean PRF Preamble (MHz)	Channel Data Rate (Mbps)	Mean PRF during modulation (MHz)	Burst Duration, T_{burst} (ns)	Symbol Rate (MHz)	Chips Per Symbol	Chip Duration, T_c (ns)	PPM duration, T_{PPM} (us)	# hopping slots, N_{slot}
{15}	128	447.5	27.96875	14.435	0.095	13.984	286.034	0.109	4096	2.235	4.577	16
{15}	32	447.5	6.9921875	3.609	0.095	3.496	71.508	0.109	4096	2.235	4.577	64
{15}	16	447.5	27.96875	14.435	0.763	13.984	35.754	0.874	512	2.235	0.572	16
{15}	4	447.5	6.9921875	3.609	0.763	3.496	8.939	0.874	512	2.235	0.572	64
{15}	2	447.5	27.96875	14.435	6.104	13.984	4.469	6.992	64	2.235	0.072	16
{15}	0.5	447.5	6.9921875	3.609	6.104	3.496	1.117	6.992	64	2.235	0.072	64
{15}	1	447.5	27.96875	14.435	12.209	13.984	2.235	13.984	32	2.235	0.036	16
{15}	0.25	447.5	6.9921875	3.609	12.209	3.496	0.559	13.984	32	2.235	0.036	64
{15}	0.5	447.5	27.96875	14.435	24.417	13.984	1.117	27.969	16	2.235	0.018	16
{15}	0.125	447.5	6.9921875	3.609	24.417	3.496	0.279	27.969	16	2.235	0.018	64

Table 4 UWB PHY Symbol Timing Parameters, Length 127 preamble

Channel Number	Pulses Burst N_{burst}	Peak PRF MHz (during modulation)	Peak PRF Preamble (MHz)	Mean PRF Preamble (MHz)	Mean PRF							
					Channel Data Rate (Mbps)	Mean PRF during modulation (MHz)	Burst Duration, T_{burst} (ns)	Symbol Duration (us)	Symbol Rate (MHz)	Chip Duration, T_c (ns)	PPM duration, T_{PPM} (us)	# hopping slots, N_{slot}
{1,2,3}	512	494	123.5	62.236	0.105	61.750	1036.437	8.291	0.121	2.024	4.146	4
{1,2,3}	64	494	123.5	62.236	0.842	61.750	129.555	1.036	0.965	2.024	0.518	4
{1,2,3}	8	494	123.5	62.236	6.739	61.750	16.194	0.130	7.719	2.024	0.065	4
{1,2,3}	4	494	123.5	62.236	13.477	61.750	8.097	0.065	15.438	2.024	0.032	4
{1,2,3}	2	494	123.5	62.236	26.954	61.750	4.049	0.032	30.875	2.024	0.016	4
{4}	512	494	123.5	62.236	0.105	61.750	1036.437	8.291	0.121	2.024	4.146	4
{4}	64	494	123.5	62.236	0.842	61.750	129.555	1.036	0.965	2.024	0.518	4
{4}	8	494	123.5	62.236	6.739	61.750	16.194	0.130	7.719	2.024	0.065	4
{4}	4	494	123.5	62.236	13.477	61.750	8.097	0.065	15.438	2.024	0.032	4
{4}	2	494	123.5	62.236	26.954	61.750	4.049	0.032	30.875	2.024	0.016	4
{5,...,12}	512	507	126.75	63.874	0.108	63.375	1009.862	8.079	0.124	1.972	4.039	4
{5,...,12}	64	507	126.75	63.874	0.864	63.375	126.233	1.010	0.990	1.972	0.505	4
{5,...,12}	8	507	126.75	63.874	6.916	63.375	15.779	0.126	7.922	1.972	0.063	4
{5,...,12}	4	507	126.75	63.874	13.832	63.375	7.890	0.063	15.844	1.972	0.032	4
{5,...,12}	2	507	126.75	63.874	27.664	63.375	3.945	0.032	31.688	1.972	0.016	4
{13}	512	439.4	109.85	55.357	0.094	54.925	1165.225	9.322	0.107	2.276	4.661	4
{13}	64	439.4	109.85	55.357	0.749	54.925	145.653	1.165	0.858	2.276	0.583	4
{13}	8	439.4	109.85	55.357	5.994	54.925	18.207	0.146	6.866	2.276	0.073	4
{13}	4	439.4	109.85	55.357	11.988	54.925	9.103	0.073	13.731	2.276	0.036	4
{13}	2	439.4	109.85	55.357	23.975	54.925	4.552	0.036	27.463	2.276	0.018	4
{14}	512	450.6666667	112.6666667	56.777	0.096	56.333	1136.095	9.089	0.110	2.219	4.544	4
{14}	64	450.6666667	112.6666667	56.777	0.768	56.333	142.012	1.136	0.880	2.219	0.568	4
{14}	8	450.6666667	112.6666667	56.777	6.147	56.333	17.751	0.142	7.042	2.219	0.071	4
{14}	4	450.6666667	112.6666667	56.777	12.295	56.333	8.876	0.071	14.083	2.219	0.036	4
{14}	2	450.6666667	112.6666667	56.777	24.590	56.333	4.438	0.036	28.167	2.219	0.018	4
{15}	512	447.5	111.875	56.378	0.095	55.938	1144.134	9.153	0.109	2.235	4.577	4
{15}	64	447.5	111.875	56.378	0.763	55.938	143.017	1.144	0.874	2.235	0.572	4
{15}	8	447.5	111.875	56.378	6.104	55.938	17.877	0.143	6.992	2.235	0.072	4
{15}	4	447.5	111.875	56.378	12.209	55.938	8.939	0.072	13.984	2.235	0.036	4
{15}	2	447.5	111.875	56.378	24.417	55.938	4.469	0.036	27.969	2.235	0.018	4

6.8a.3.3.1 UWB PHY Symbol Mapping

The UWB PHY shall map groups of two consecutive bits into modulation symbols according to Table 7

Table 7 UWB PHY Bit to Modulation Symbol Mapping

Information bits ($b_1 b_0$)	Modulation Symbols ($g_i g_0$)
00	-10
01	-11
10	10
11	11

6.8a.3.3.2 UWB PHY Pulse Shape

The pulse shape, $p(t)$, of the UWB PHY shall be constrained by its cross correlation properties with a standard reference pulse, $r(t)$. The cross correlation between two waveforms is defined as

$$\phi(\tau) = \frac{1}{\sqrt{E_r E_p}} \int_{-\infty}^{\infty} r(t) p^*(t + \tau) dt \tag{4}$$

The reference, $r(t)$, pulse used by the UWB PHY is a root raised cosine pulse with roll-off factor of $\beta = 0.6$. Mathematically this is

$$r(t) = \sin c \left(\frac{\pi t}{T_p} \right) \frac{\cos(\pi \beta t / T_p)}{1 - (2 \beta t / T_p)^2} \tag{5}$$

In the above equation T_p is the pulse duration. Table ZZ shows the required pulse duration for each channel

Table 8 Required pulse durations in each channel

Channel Number	Pulse duration, T_p , (ns)
{1,2,3}	2.0243
{4}	0.6748
{5,6,7,8,9,10,11,12}	1.9724
{13}	0.7586
{14}	0.7396
{15}	0.7449

In order for a UWB PHY transmitter to be compliant with the standard the transmitted pulse shall have a cross correlation coefficient that is greater or equal to 0.7, that is

$$\phi(0) = \frac{1}{\sqrt{E_r E_p}} \int_{-\infty}^{\infty} r(t) p^*(t) dt \geq 0.7 \tag{6}$$

Equation 7 {what is this equation?}

An FFD shall be capable of receiving the mandatory UWB PHY pulse shape whenever the receiver is enabled.

6.8a.3.3.3 UWB PHY Optional Pulse Shapes

An optional pulse shape that consists of a weighted linear combination of the pulses. This new optional pulseshape is denoted $p'(t)$ and is the sum of N weighted and delayed “fundamental” pulses $p(t)$

$$p'(t) = \sum_{i=1}^N a_i p(t - \tau_i)$$

8

where $p(t)$ has to follow the specifications of fundamental pulses according to Sec. 6.8a.3.3.2. The number of pulses N is set to a fixed value of 4 (though smaller values can be realized by setting the amplitudes of some of the pulses to zero. The values of the pulse delays shall be limited to $0 \leq \tau_i \leq 4ns$. The numerical values of the delays and amplitudes of the pulses shall be transmitted following the general framework of optional pulsheshapes, as defined in {Sec. ??? }

6.8a.3.3.4 UWB PHY Optional Chirp on UWB (CoU) pulses

This clause specifies an optional Chirp on UWB (CoU) pulses. The purpose of CoU pulses is to provide an additional dimension (besides frequency bands and DS codes) to support SOP as well as to achieve better ranging accuracy.

Since CoU is an optional mode of pulse shapes in addition to the mandatory pulse shape, all modulation specifications will remain the same as they are for the mandatory pulse shape except those defined description of the CoU pulses when a device implements the CoU option.

A mathematical representation of a CoU pulse at baseband is given by Equation (1) and a graphical example of chirped DS pulse is shown in Figure o-1.

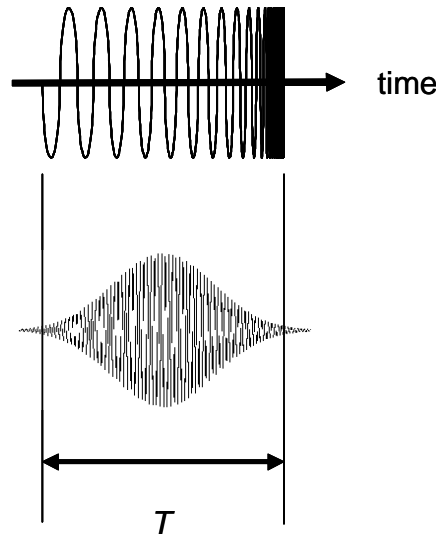

Figure o-1 Graphical view of a CoU pulse.

$$P_{CoU}(t) = \begin{cases} P(t) \exp\left(j\left(-\frac{\pi\mu t^2}{2}\right)\right) & ; \quad -\frac{T}{2} \leq t \leq \frac{T}{2} \\ 0 & ; \quad otherwise \end{cases} \quad (1)$$

where $P(t)$ denotes the mandatory pulse shape and $\mu = B/T$ the chirping rate (chirping slope). Moreover, B and T are the bandwidth and time duration of the CoU pulse respectively. When Raised cosine pulse is used as the mandatory pulse, we have

$$P(t) = \begin{cases} 1 & ; \quad |t| \leq \frac{1-\alpha}{1+\alpha} \frac{T}{2} \\ \frac{1}{2} \left(1 + \cos \left(\frac{(1+\alpha)\pi}{\alpha T} \left(|t| - \frac{(1-\alpha)T}{(1+\alpha)2} \right) \right) \right) & ; \quad \frac{1-\alpha}{1+\alpha} \frac{T}{2} < |t| \leq \frac{T}{2} \\ 1 & ; \quad |t| > \frac{T}{2} \end{cases} \quad (2)$$

It can be seen from Equation (1) that CoU is an operation added to the mandatory pulse. When a CoU pulse is transmitted, the receiver needs to perform a matched de-chirp operation to demodulate the signal.

The optional CoU pulses are admitted with two slopes (Ch. 1 and Ch. 2) per each DS code per each 500MHz bandwidth and are admitted with four slopes (from Ch. 3 to Ch. 6) per each DS code per each 1.5GHz bandwidth as listed in Table o-1. It should be noted that a 500MHz bandwidth implies the 494MHz and 507MHz bandwidths and that a 1.5GHz bandwidth implies the 1.4GHz and 1.3GHz bandwidths, given in Section 6.1.2a(??).

Table o-1 CoU channel slopes

Channel number	μ (slopes)
Ch. 1	500MHz/100ns
Ch. 2	-500MHz/100ns
Ch. 3	1GHz/200ns
Ch. 4	-1GHz/200ns
Ch. 5	1.4GHz/300ns
Ch. 6	-1.4GHz/300ns

6.8a.3.3.5 UWB PHY Optional Continuous Spectrum (CS) pulses

This clause specifies an optional continuous spectrum (CS) pulses. A CS pulse is obtained by passing the mandatory pulse through an all-passing CS filter. The CS filter introduces group delays to the input pulse. The purpose of the optional CS pulses is to reduce the interference level between different piconets so as to enhance SOP performance.

Since CS is an optional mode of pulse shapes in addition to the mandatory pulse shape, all modulation specifications will remain the same as they are for the mandatory pulse shape except those defined description of the CS pulses when a device implements the CS option.

A mathematical representation of a CS pulse is given by Equation (3) and some examples of CS pulses are shown in Figure o-2.

$$g_{cs}(t) = \int G(f) \exp\{-j2\pi f [t - \tau(f)]\} df \quad (3)$$

where, $g(t)$ denotes the original mandatory pulse, $\tau(f)$ the group delay with a unit of seconds/Hz. $G(f)$ and $g(t)$ meet the following equation.

$$G(f) = \int g(t) \exp(-j2\pi ft) dt \quad (4)$$

It can be seen from Equation (3) that CS filtering is an operation added to the mandatory pulse. When a CS pulse is transmitted, the receiver needs to perform an inverse CS filtering (CS^{-1}) operation to demodulate the signal.

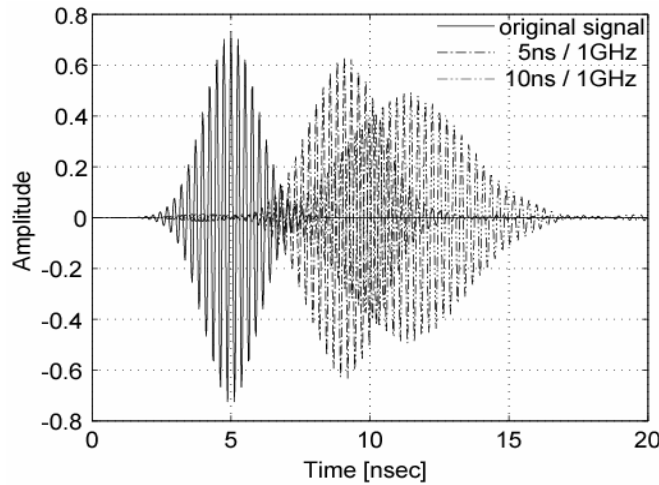

Figure o-2 Examples of CS pulses.

The optional CS pulses are admitted with two group delay values (No. 1 and No. 2) per each DS code per each 500MHz bandwidth and are admitted with four group delay values (from No. 3 to No. 6) per each DS code per each 1.5GHz bandwidth as listed in Table o-2. It should be noted that a 500MHz bandwidth implies the 494MHz and 507MHz bandwidths and that a 1.5GHz bandwidth implies the 1.4GHz and 1.3GHz bandwidths given in Section 6.1.2a(???)

Table o-2 CS group delays

CS pulse number	τ (Group delay)
No.1	2ns/500MHz
No.2	-2ns/500MHz
No.3	5ns/1GHz
No.4	-5ns/1GHz
No.5	10ns/1GHz
No.6	-10ns/1GHz

6.8a.3.3.6 UWB PHY Optional Chaotic pulses

Another optional pulse shape that may be used is a chaotic waveform. This optional pulse shape shall only be used when all other devices within the PAN are also using a chaotic pulse.

A generator of chaotic oscillations a model of ring-structure oscillator with 4.5 degrees of freedom can be represented with the combination of following first and second order differential equations.

$$\begin{aligned}
 T\dot{x}_1 + x_1 &= mF(x_5) \\
 \ddot{x}_2 + \alpha_2\dot{x}_2 + \omega_2^2x_2 &= \omega_2^2x_1 \\
 \ddot{x}_3 + \alpha_3\dot{x}_3 + \omega_3^2x_3 &= \alpha_3\dot{x}_2 \\
 \ddot{x}_4 + \alpha_4\dot{x}_4 + \omega_4^2x_4 &= \alpha_4\dot{x}_3 \\
 \ddot{x}_5 + \alpha_5\dot{x}_5 + \omega_5^2x_5 &= \alpha_5\dot{x}_4
 \end{aligned} \tag{1}$$

where, m , α_2 , α_3 , α_4 , α_5 , ω_2 , ω_3 , ω_4 , ω_5 , T , e_1 , and e_2 are a set of parameters which is required to generate chaotic signal for a specific RF band, and the $F(z)$ is non-linear amplifier which is represented by a piecewise-linear function

$$F(z) = \left[|z + E_1| - |z - E_1| + \frac{|z - E_2| - |z + E_2|}{2} \right] \tag{2}$$

and the function $F(z)$ is plotted in Figure 1

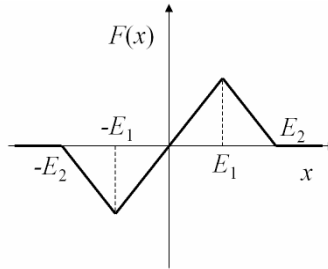

Figure 3 Nonlinear function F

The Chaotic signal is obtained from $c(t) = x_5(t)$, the last second order differential equations

The numerical values of the 15 frequency bands for the Chaotic signal shall be as defined in the [Section 6.1.2.1b](#)

The recommended Chaotic signal generator parameters for the mandatory Channel 1 are $m=200$, $T=2.5$, $\alpha_2=0.2$, $\alpha_3=2.55$, $\alpha_4=0.3912$, $\alpha_5=2.2$, $\omega_2=1$, $\omega_3=0.93$, $\omega_4=0.989$, $\omega_5=0.989$, $E_1=0.5$ and $E_2=1$.

Others Chaotic signals for the optional channel can be obtained by adjusting the values of the parameters. (Jae-Hyon, for completeness I think the rest of the parameters for all the other frequency bands need to be specified.)

6.8a.3.3.6.1 UWB PHY Modulation (Chaotic)

When using the optional chaotic pulse the UWB-PHY is assumed to be operating in a homogenous network with other chaotic based transmitters. Rather than use the modulation method described in 6.8a.3.2 the chaotic UWB-PHY shall use OOK or optionally DBSK modulation techniques.

In case of preamble transmission, a single chip bit of the S code shall be mapped to a Chaotic On-off Keying (OOK) chaotic pulse or Differential Chaos Shift Keying (DCSK) pulse as shown in Table 1 and 2 respectively. The duration of the pulse shall be $T_{DC} = 32.3887$ nsec. **(Jae Hyon Again it might be better to list all the possible T_{DC} 's for the frequency bands in which you want to operate)**

Table 9 Ternary Code to OOK Chaotic pulse Mapping

Ternary Code Chip (b_i)	OOK Chaotic Pulse
-1	$c(t)$
0	0
+1	$-c(t)$

Table 10 Ternary Code to DCSK pulse Mapping

Ternary Code Chip (b_i)	DCSK Pulse
-1	Ref. & (- Data)
0	0
+1	Ref. & (+ Data)

In case of the OOK modulation, the following equation

$$\begin{cases} \sum_{j=1}^{Code_length} c(t) \left[p(t + j|s_j|T_{DC}) \right]; s_j \neq 0 \\ 0; s_j = 0, (j-1)T_{DC} \leq t \leq jT_{DC} \end{cases} \quad (3)$$

where,

$$p(t) = \begin{cases} 1; |t| \leq \frac{T_{DC}}{2} \\ 0; otherwise \end{cases}$$

The $c(t)$ is the waveform of chaotic symbol, s_j is the element of preamble code vector

$\mathbf{S} = [s_1, \dots, s_{Code_length}]$ which takes the possible values are $\{-1, 0, +1\}$, $p(t)$ is the transmitted pulse shape at the input to the antenna, and T_{PPM} is the duration of the binary pulse position modulation time slot.

In case of optional DCSK optional modulation for the Chaotic waveform preamble, we have following equations

$$\begin{cases} \sum_{j=1}^{Code_length} c(t) \left[p(t + j|s_j|T_{DC}) + p(t + j|s_j|T_{DC} - \frac{T_{DC}}{2}) \right]; s_j \neq 0 \\ 0; s_j = 0, (j-1)T_{DC} \leq t \leq jT_{DC} \end{cases} \quad (4)$$

where, $c(t)$, s_j , and T_{PPM} are as same as OOK and $p(t)$ is as following

$$p(t) = \begin{cases} 1; & |t| \leq \frac{T_{DC}}{4} \\ 0; & \text{otherwise} \end{cases}$$

The DCSK pulse is shown in Figure 3

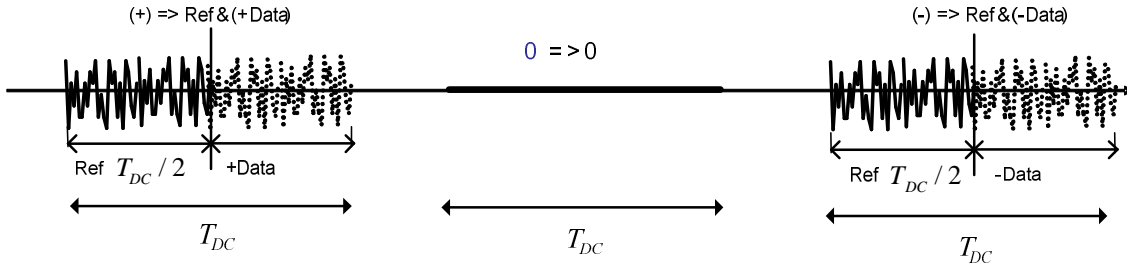

Figure 4 UWB PHY Symbol Timing (Chaotic)

6.8a.3.3.6.2 UWB PHY Symbol (Chaotic)

The UWB PHY symbol can be expressed with the following equation shown below, where, $x_c^{(k)}(t)$ is the waveform of the k^{th} information bearing symbol, g_0 and g_1 are the modulation symbols obtained from a mapping of the coded bits, $p(t)$ is the transmitted pulse shape at the input to the antenna, and T_{PPM} is the duration of the binary pulse position modulation time slot. The hopping sequence $h^{(k)}$, provides suppression of multi-user interference.

For the case of OOK modulation, the T_{PPM} time shift is occurred due to the change of g_0 symbol type and time slot with separation T_{DC} of is determined by the hopping sequences

$$x_{DC_OOK}^{(k)}(t) = c(t) \left[p(t - g_0^{(k)} T_{PPM} - h^{(k)} T_{DC}) \right] \quad (6)$$

where,

$$p(t) = \begin{cases} 1; & |t| \leq \frac{T_{DC}}{2} \\ 0; & \text{otherwise} \end{cases}$$

For the case of DCSK modulation, the procedure of time shift and determination of time slot is same as OOK modulation. In this case the left half of T_{DC} is occupied by the reference signal and g_1 is determined by the sing of bit. The hopping sequence remains as same as in case of OOK, and it is determined by the scrambler.

$$x_{DC_DCSK}^{(k)}(t) = c(t) \left[p(t - g_0^{(k)} T_{PPM} - h^{(k)} T_{DC}) + g_1^{(k)} p(t - g_0^{(k)} T_{PPM} - \frac{T_{DC}}{2} - h^{(k)} T_{DC}) \right] \quad (5)$$

where,

$$p(t) = \begin{cases} 1; & |t| \leq \frac{T_{DC}}{4} \\ 0; & \text{otherwise} \end{cases}$$

The Table 3 shows the modulation symbol bit to Chaotic pulse mapping relationship.

Table 11 UWB PHY Bit to Modulation Symbol Mapping

Information bits ($b_1 b_0$)	Modulation Symbols ($g_1 g_0$)	Chaotic Pulse OOK	Chaotic Pulse DCSK	Position
00	-10	0	Ref & (-Data)	Left
01	-11	1	Ref & (-Data)	Right
10	10	0	Ref & (+Data)	Left
11	11	1	Ref & (+Data)	Right

All the preamble field length, and ranging/acquisition codes S_i shall be as defined in the Table 1 and Table 2 in Section 6.8a.2

6.8a.4. UWB PHY Spreading and Hopping Sequences

The constituent pulses in each burst are scrambled by applying a time varying scrambling sequence $\{s_j\}$ in equation 3}. This scrambler is simply a the pseudo-random binary sequence (PRBS) defined by a polynomial generator. The polynomial generator, $g(D)$, for the pseudo-random binary sequence (PRBS) generator shall be $g(D) = 1 + D^{14} + D^{15}$, where D is a single bit delay element. The polynomial not only forms a maximal length sequence, but is also a primitive polynomial. Using this generator polynomial, the corresponding PRBS, s_p is generated as

$$s_j = s_{j-14} \oplus s_{j-15}, \quad j = 0, 1, 2, \dots$$

where “ \oplus ” denotes modulo-2 addition.

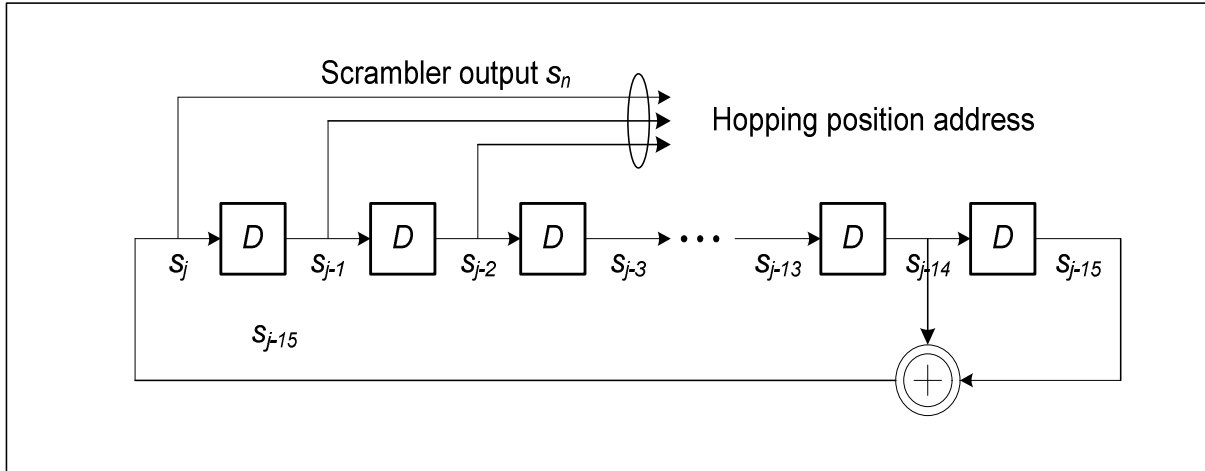

Figure 3 Realization of the scrambler linear feedback shift registers

Furthermore the hopping sequence is derived from the same linear feedback shift registers by using the output of the first three registers. Specifically, when each symbol, $x^{(k)}(t)$, is generated by the UWB PHY the spreader of {**Error! Reference source not found.**} is run at the chip rate for N_{burst} cycles the N_{burst} consecutive outputs of the spreader are the spreading sequence for the symbol ($s_j, j = 1, 2, \dots, N_{burst}$). Additionally, the current hopping position, $h^{(k)}$ is determined according to the following equation

$$h^{(k)} = s_j \times 2^0 + s_{j-1} \times 2^1 + s_{j-2} \times 2^2$$

Here the values of the state variables are sampled at the start of the transmission of the current modulation symbol.

6.8a.5. UWB PHY Channel coding within a band

{TBD (Phil and Ismail aren't sure what goes here is it description of when to start scrambling and FEC within a PHY PDU, e.g., after the PHY header?)}

6.8a.6. UWB PHY Forward Error Correction

The FEC used by the UWB PHY is a concatenated code consisting of an outer Reed-Solomon (RS) systematic block code and an inner systematic convolutional code. The outer RS code shall be a $RS_6(K+8,K)$ over Galois field $GF(2^6)$. The Galois field $GF(2^6)$ is built as an extension of $GF(2)$. The systematic Reed Solomon code shall use the generator polynomial

$$g(x) = \prod_{k=0}^7 (x + a^k)$$

where $a = 010000$ is a root of the binary primitive polynomial $1+x+x^6$ in $GF(2^6)$. Both RS encoding with default codeword operation ($K = 55$) and shortened codeword operation (see 6.8a.6.1.4), as defined below, shall be required.

6.8a.6.1 Reed Solomon Default Codeword Operation

In default codeword operation, $RS_6(63,55)$, a block of 330 bits is encoded into a codeword of 378 bits. The RS encoding procedure is performed in the following 3 steps: bit to symbol conversion, encoding, and symbol to bit conversion

The outer encoding of the frame shall be performed in the following manner. The PLCP header (consisting of the PHY header, the MAC header and the HCS) shall be encoded using shortened codeword operation as an outer code. Next, the MPDU (MAC frame body followed by the FCS) shall be partitioned into blocks of 330 bits. Each block shall be encoded as $RS_6(63,55)$ using default codeword operation. The last block shall be shortened to the appropriate length using the shortened codeword operation.

6.8a.6.1.1 Bit to Symbol Conversion

The information bits $\{d(0), d(1), \dots, d(329)\}$ are converted into 55 RS symbols $\{D(0), D(1), \dots, D(54)\}$ as following:

$$D(k) = 32d(6k+5) + 16d(6k+4) + 8d(6k+3) + 4d(6k+2) + 2d(6k+1) + d(6k) \text{ for } k = 0, 1, \dots, 54$$

Resulting 6-bit symbols are presented as:

$$D(k) = \{d(6k+5), d(6k+5), d(6k+4), d(6k+3), d(6k+2), d(6k+1), d(6k)\} \text{ for } k = 0, 1, \dots, 54$$

where $d(6k+5), \dots, d(6k)$ are ordered from the most significant bit (MSB) to the less significant bit (LSB). The polynomial representation of a single information symbol over $GF(2^6)$ in terms of a is given by:

$$D_a(k) = a^5d(6k+5) + a^4d(6k+4) + a^3d(6k+3) + a^2d(6k+2) + a^1d(6k+1) + d(6k)$$

6.8a.6.1.2 Encoding

The information symbols $D(0), D(1), \dots, D(54)$ are encoded by systematic $RS_6(63,55)$ code with output symbols $U(0), U(1), \dots, U(54)$ ordered as:

$$\begin{aligned} U(k) &= D(k) && \text{for } k = 0, 1, \dots, 54; \\ U(k) &= P(k) && \text{for } k = 55, 56, \dots, 62; \end{aligned}$$

where $P(k)$ are parity check symbols added by $RS_6(63,55)$ encoder.

Information symbols are ordered in the descending polynomial order such that $D_a(54)$ corresponds to the lowest degree term of: $D(x) = D_a(54) + D_a(53)x + \dots + D_a(0)x^{54}$, where $D(x)$ is the polynomial representation of information symbols $\{D(0), D(1), \dots, D(54)\}$ over Galois field.

Parity check symbols in polynomial representation over Galois field are ordered in the descending polynomial order such that $P_a(62)$ is the lowest degree of $P(x) = P_a(62) + P_a(61)x + \dots + P_a(0)x^7$. The parity check symbols are calculated as:

$$P(x) = \text{remainder} [x^8D(x)/g(x)], \text{ and } U(x) = D(x) + x^8P(x), \text{ i.e.}$$

$$\begin{aligned} U_a(k) &= D_a(k) \text{ for } k = 0, 1, \dots, 54; \\ U_a(k) &= P_a(k) \text{ for } k = 55, 56, \dots, 62. \end{aligned}$$

6.8a.6.1.3 Symbol to Bit Conversion

The output symbols $\{U_a(0), U_a(1), \dots, U_a(62)\}$ are converted back into symbols $\{U(0), U(1), \dots, U(62)\}$ and then into binary with LSB coming out first, resulting in a block of 378 bits $\{u(0), u(1), \dots, u(377)\}$.

6.8a.6.1.4 Shortened Codeword Operation

When a block of bits consists of less than 55 RS symbols (or $N = 55 \times 6 = 330$ bits) the outer code shall be shortened. Shortened codeword operation, $RS_6(K, K+8)$, of a block of N bits is described by the following steps:

- Expand the block to 330 bits by adding $330-N$ dump (zero) bits
- Encode the expanded block using default codeword operation (see 6.8a.6.1-6.8a.6.3)
- Remove the $330-N$ dump bits,

6.8a.6.2 Inner Convolution Coder Operation

The inner convolutional encoder shall use the rate $R = 1/2$ code with generator polynomials, $g_0 = [010]_2$ and $g_1 = [101]_2$, as shown in Figure 3. In order to return the encoder to the all zero state one 'zero' bit shall be appended to the PDPDU by the UWB PHY.

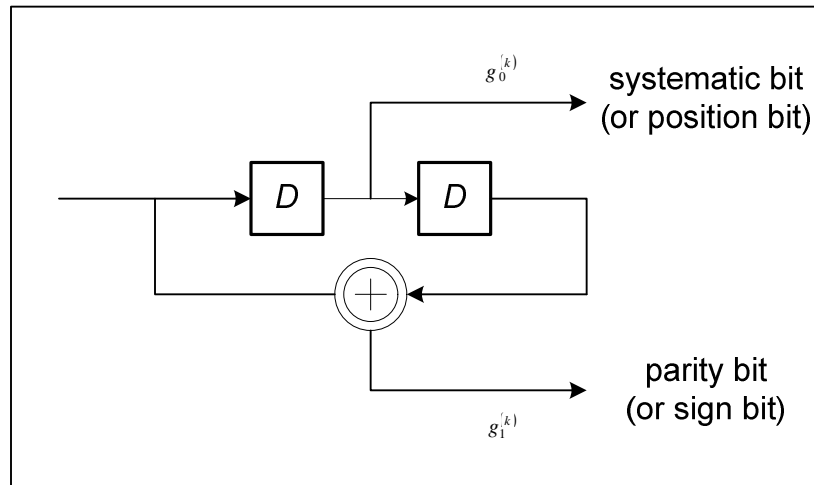

Figure 5 systematic convolutional encoder

Change in sub-clause 6.9

6.9 General radio specifications

The specifications in 6.9.1 through 6.9.9 apply to the 2450 MHz DS PHY described in section 6.5.1 through 6.5.3; the CSS PHY described in 6.5a, the UWB PHY described in section 6.8a and the 868/915 MHz PHYs.

6.9.1 TX-to-RX turnaround time

The TX-to-RX turnaround time shall be less than or equal to $aTurnaroundTime$ (see 6.4.1).

The TX-to-RX turnaround time is defined as the shortest time possible at the air interface from the trailing edge of the last chip (of the last symbol) of a transmitted PPDU to the leading edge of the first chip (of the first symbol) of the next received PPDU.

The TX-to-RX turnaround time shall be less than or equal to the RX-to-TX turnaround time.

6.9.2 RX-to-TX turnaround time

The RX-to-TX turnaround time shall be less than or equal to $aTurnaroundTime$ (see 6.4.1).

The RX-to-TX turnaround time is defined as the shortest time possible at the air interface from the trailing edge of the last chip (of the last symbol) of a received PPDU to the leading edge of the first chip (of the first symbol) of the next transmitted PPDU.

6.9.3 Error-vector magnitude (EVM) definition

The modulation accuracy of the transmitter is determined with an EVM measurement. In order to calculate the EVM measurement, a time record of N received complex chip values is captured. For each received complex chip, a decision is made about which complex chip value was transmitted. The ideal position of the chosen complex chip (the center of the decision box) is represented by the vector.

The error vector is defined as the distance from this ideal position to the actual position of the received point (see Figure 28).

Thus, the received vector is the sum of the ideal vector and the error vector.

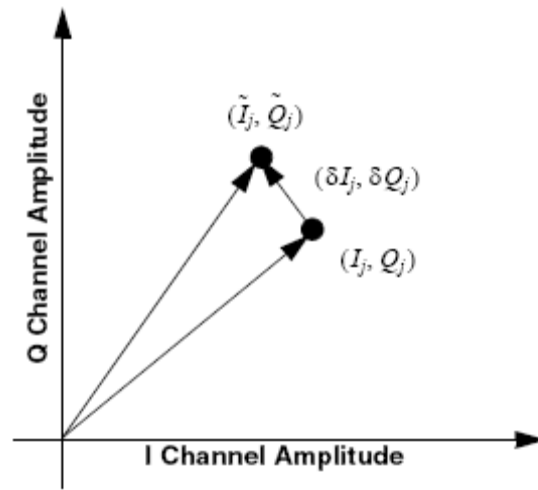

Figure 28—Error vector calculation

Thus, the received vector is the sum of the ideal vector and the error vector.

$$(I_j Q_j) = (I_j, Q_j) + (\delta I_j, \delta Q_j) \quad (12)$$

The EVM is defined as

$$EVM \equiv \sqrt{\frac{\frac{1}{N} \sum_{j=1}^N (\delta I_j^2 + \delta Q_j^2)}{S^2}} \times 100\%$$

Where S is the magnitude of the vector to the ideal constellation point,

$(I_j Q_j) = (I_j, Q_j) + (\delta I_j, \delta Q_j)$ is the error vector.

6.9.3.1 EVM calculated values

With the exception of the UWB PHY transmitter as described in 6.a, a transmitter shall have EVM values of less than 35% when measured for 1000 chips. The error-vector measurement shall be made on baseband I and Q chips after recovery through a reference receiver system. The reference receiver shall perform carrier lock, symbol timing recovery, and amplitude adjustment while making the measurements.

6.9.4 Transmit center frequency tolerance

The transmitted center frequency tolerance shall be ± 40 ppm maximum. It should be noted that a reduced frequency tolerance could facilitate a more precise range outcome for UWB devices.

6.9.5 Transmit power

A transmitter shall be capable of transmitting at least -3 dBm with the exception of UWB devices which have no minimum transmit power dictated by this standard. Devices should transmit lower power when possible in order to reduce interference to other devices and systems.

The maximum transmit power is limited by local regulatory bodies.

6.9.6 Receiver maximum input level of desired signal

The receiver maximum input level is the maximum power level of the desired signal present at the input of the receiver for which the error rate criterion in 6.1.7 is met. A receiver shall have a receiver maximum input level greater than or equal to -20 dBm with the exception of a UWB receiver, the UWB receiver shall have a maximum input level greater than or equal to -45 dBm/MHz.

6.9.7 Receiver ED

The receiver ED measurement is intended for use by a network layer as part of a channel selection algorithm. It is an estimate of the received signal power within the bandwidth of the channel. No attempt is made to identify or decode signals on the channel. The ED measurement time, to average over, shall be equal to 8 symbol periods.

The ED result shall be reported to the MLME using PLME-ED.confirm (see 6.2.2.4) as an 8 bit integer ranging from 0x00 to 0xff. The minimum ED value (zero) shall indicate received power less than 10 dB above the specified receiver sensitivity (see 6.5.3.3 and 6.6.3.4), and the range of received power spanned by the ED values shall be at least 40 dB. Within this range, the mapping from the received power in decibels to ED value shall be linear with an accuracy of ± 6 dB.

6.9.8 LQI

The LQI measurement is a characterization of the strength and/or quality of a received packet. The measurement may be implemented using receiver ED, a signal-to-noise ratio estimation, or a combination of these methods. The use of the LQI result by the network or application layers is not specified in this standard.

The LQI measurement shall be performed for each received packet, and the result shall be reported to the MAC sublayer using PD-DATA.indication (see 6.2.1.3) as an integer ranging from 0x00 to 0xff. The minimum and maximum LQI values (0x00 and 0xff) should be associated with the lowest and highest quality compliant signals detectable by the receiver, and LQI values in between should be uniformly distributed between these two limits. At least eight unique values of LQI shall be used.

6.9.9 CCA

The PHY shall provide the capability to perform CCA according to at least one of the following three methods:

— CCA Mode 1: Energy above threshold. CCA shall report a busy medium upon detecting any energy above the ED threshold.

— CCA Mode 2: Carrier sense only. CCA shall report a busy medium only upon the detection of an IEEE 802.15.4b signal with the same modulation and spreading characteristics of the PHY that is currently in use by the device. This signal may be above or below the ED threshold.

— CCA Mode 3: Carrier sense with energy above threshold. CCA shall report a busy medium using a logical combination of (i) detection of a signal with the modulation and spreading characteristics of IEEE 802.15.4b and (ii) energy above the ED threshold, where the logical operator may be AND or OR.

— CCA Mode 4: Aloha. CCA shall always report an idle medium.

— CCA Mode 5: UWB Preamble-only sense. The CCA shall “listen” for a preamble as specified in section 6.8a for period not shorter than the maximum packet size along with the maximum period for acknowledgement; the CCA shall report a busy medium upon the detection of a preamble.

For any of the CCA modes, if the PLME-CCA.request primitive (see 6.2.2.1) is received by the PHY during reception of a PPDU, CCA shall report a busy medium. PPDU reception is considered to be in progress following detection of the SFD, and it remains in progress until the number of octets specified by the decoded PHR has been received.

A busy channel shall be indicated by the PLME-CCA.confirm primitive (6.2.2.2) with a status of BUSY. A clear channel shall be indicated by the PLME-CCA.confirm primitive (6.2.2.2) with a status of IDLE. The PHY PIB attribute *phyCCAMode* (see 6.4) shall indicate the appropriate operation mode. The CCA parameters are subject to the following criteria:

- a) The ED threshold shall correspond to a received signal power of at most 10 dB above the specified receiver sensitivity (see 6.5.3.3 and 6.6.3.4).
- b) The CCA detection time shall be equal to 8 symbol periods.

7. MAC Sub-Layer Specification

7.1 MAC Sub-Layer Service Specification

7.1.1 MAC Data Service

7.1.1.1 MCPS-DATA.request

7.1.1.1.1 Semantics of the Service Primitive

The semantics of the MCPS-DATA.request primitive is as follows:

```
MCPS-DATA.request (
    SrcAddrMode,
    SrcPANId,
    SrcAddr,
    DstAddrMode,
    DstPANId,
    DstAddr,
    msduLength,
    msdu,
    msduHandle,
    TxOptions,
    SecurityLevel,
    KeyIdMode,
    KeyId,
    ServiceType
)
```

Table 41 specifies the parameters for the MCPS-DATA.request primitive.

Table 41—MCPS-DATA.request parameters

Name	Type	Valid range	Description
...
ServiceType	Enumeration	SERVICE_DATA, SERVICE_RANGING	Optional. The service type of the MSDU to be transmitted by the MAC sublayer entity.

7.1.1.2 MCPS-DATA.confirm

7.1.1.2.1 Semantics of the Service Primitive

The semantics of the MCPS-DATA.confirm primitive is as follows:

```

MCPS-DATA.confirm (
    msduHandle,
    status,
    Timestamp,
    TimestampAck,
    mpduLinkQualityAck
)

```

Table 42 specifies the parameters for the MCPS-DATA.confirm primitive.

Table 42—MCPS-DATA.confirm parameters

Name	Type	Valid range	Description
...
Timestamp	List of Integer	0x000000-0xFFFFFFFF	<p>Optional. List of two values. The first value represents the time in symbols, at which the data were transmitted (see 7.5.4.1).</p> <p>The value(s) of this parameter will only be considered valid if the value of the status parameter is SUCCESS; if the status parameter is not equal to SUCCESS, the value of the Timestamp parameter shall not be used for any other purpose. The symbol boundary is determined by <i>macSyncSymbolOffset</i> (see Table 86).</p> <p>This is a 24-bit value, and the accuracy of this value shall be a minimum of 20 bits, with the lowest 4 bits being the least significant.</p> <p>The second value determines the symbol boundary with high resolution (see 6.2.1.1.4) instead of by the <i>macSyncSymbolOffset</i> attribute. Implementation specific.</p>
TimestampAck	List of Integer	0x000000-0xFFFFFFFF	<p>Optional. List of two values. The first value represents the time in symbols, at which the acknowledgment frame was received.</p> <p>The values of this parameter will only be considered valid if the value of the status parameter is SUCCESS; if the status parameter is not equal to SUCCESS, the value of the Timestamp parameter shall not be used for any other purpose.</p> <p>This is a 24-bit value, and the accuracy of this value shall be a minimum of 20 bits, with the lowest 4 bits being the least significant.</p> <p>The second value determines the symbol boundary with high resolution. Implementation specific.</p> <p>Parameter is only valid, when an acknowledged transmission was requested and the acknowledgment was received successfully.</p>

Name	Type	Valid range	Description
mpduLinkQualityAck	Bitmap	0x00000000-0xFFFFFFFF	<p>Optional. The 8 LSBs represent the link quality indication (LQI) value measured during reception of the acknowledgment frame. Lower values represent lower LQI (see 6.9.8).</p> <p>The 24 MSBs represent the figure of merit information of a ranging operation (see 6.8.3.4).</p> <p>Parameter is only valid, when an acknowledged transmission was requested.</p>

7.1.1.3 MCPS-DATA.indication

7.1.1.3.1 Semantics of the Service Primitive

The semantics of the MCPS-DATA.indication primitive is as follows:

```

MCPS-DATA.indication (
    SrcAddrMode,
    SrcPANId,
    SrcAddr,
    DstAddrMode,
    DstPANId
    DstAddr,
    msduLength,
    msdu,
    mpduLinkQuality,
    SecurityLevel,
    DSN,
    Timestamp,
    TimestampAck,
    GrpAddress,
    SrcAddrMatch,
    status,
    ServiceType
)
    
```

Table 43 specifies the parameters for the MCPS-DATA.indication primitive.

Table 43—MCPS-DATA.indication parameters

Name	Type	Valid range	Description
...
mpduLinkQuality	Bitmap	0x00000000-0xFFFFFFFF	<p>The 8 LSBs represent the link quality indication (LQI) value measured during reception of the acknowledgment frame. Lower values represent lower LQI (see 6.9.8).</p> <p>Optional. The 24 MSBs represent the figure of merit information of a ranging operation (see 6.8.3.4).</p>
...

Name	Type	Valid range	Description
Timestamp	List of Integer	0x000000-0xFFFFFFFF	<p>Optional. List of two values. List of three values. The first value represents the time in symbols, at which the data were received (see 7.5.4.1).</p> <p>The symbol boundary is determined by <i>macSyncSymbolOffset</i> (see Table 86).</p> <p>This is a 24-bit value, and the accuracy of this value shall be a minimum of 20 bits, with the lowest 4 bits being the least significant.</p> <p>The second value determines the symbol boundary with high resolution (see 6.2.1.2.1) instead of by the <i>macSyncSymbolOffset</i> attribute. Implementation specific.</p>
TimestampAck	List of Integer	0x000000-0xFFFFFFFF	<p>Optional. List of two values. The first value represents the time in symbols, at which the acknowledgment frame was transmitted.</p> <p>The value of this parameter will only be considered valid if the value of the status parameter is ACK; if the status parameter is not equal to ACK, the value of the Timestamp parameter shall not be used for any other purpose.</p> <p>This is a 24-bit value, and the accuracy of this value shall be a minimum of 20 bits, with the lowest 4 bits being the least significant.</p> <p>The second value determines the symbol boundary with high resolution. Implementation specific.</p>
status	Enumeration	ACK, NO_ACK	Optional. The status of the acknowledgment.
ServiceType	Enumeration	SERVICE_DATA, SERVICE_RANGING	Optional. The service type of the MSDU received is indicated to the higher layer.

7.1.1.3.2 When Generated

....

If the MPDU was received successfully, and an acknowledgment, if requested, was transmitted, the MAC sub-layer will issue the MCPS-DATA.indication primitive with a status of ACK, otherwise with a status of NO_ACK.

....

7.2 MAC Frame Formats

7.2.2.4 MAC command frame format

Change the following sub-clause

7.2.2.4.3 Command payload field

The command payload field contains the MAC command itself. If protection is required on an outgoing command frame, this frame shall be processed using information, such as the security level, contained in the auxiliary security header. The device shall process an incoming command frame using information, such as the security enabled subfield of the frame control field, and information, such as the security level, contained in the auxiliary security header (if present) of the incoming frame, in order to determine the intended MAC command. If the MAC command type indicates that it is a private ranging notification packet, the payload should contain a reference or index to Ternary sequences to be used in preambles of the data packets to be exchanged for ranging. It is recommended that preamble of forward data packet and backward data packet is formed from different Ternary sequences to increase privacy level. In this case, the payload should contain an identifier index for each sequence. The receiving device should also infer from the command frame identifier that if it is a command for range notification, which is used for private ranging, it shall dither its turn-around time. The formats of the individual commands are described in 7.3.

7.3 MAC Command Frames

Insert following the first paragraph

When using the 3100 to 10000 MHz UWB PHY, the commands: Association request, Association response, and Disassociation notification shall only be transmitted using the mandatory pulse shape.

Insert row before last row of table 82
Change last row in table 82

Table 82 MAC command frames

Command frame identifier	Command frame	RFD		Sub-clause
		Tx	Rx	
0x0a	Range notification		X	7.3.4.1
0x0ab-0xff	Reserved			-----

Insert 7.3.4 and its sub-clauses after sub-clause 7.3.3.1.2

7.3.4 Private Ranging

These commands are used to allow devices to perform private ranging with their coordinators.

7.3.4.1 Range notification

Range notification command is sent by a ranging source (typically a coordinator) to one of its target associated devices. It is transmitted prior to ranging data packet exchanges and only if the ranging is desired to be performed in the private mode. Coordinators should be capable of sending this command, while coordinators and RFDs are required to be capable of receiving it.

Range notification command shall be formatted as illustrated in Figure 65a.

octet: 17/23	1	1 bit	1	1
MHR Fields	Command frame identifier (see Table 67)	Ternary Sequence Length	Forward preamble Ternary sequence identifier index	Backward preamble Ternary sequence identifier index

Figure 65a Range notification command format

7.3.4.1.1 MHR Fields

The fields of the MHR of the general MAC frame format (see Figure 41) shall be specified as indicated in this sub-clause.

The destination addressing mode subfield of the frame control field shall be set to 2 (i.e., 16 bit short addressing), and the source addressing mode subfield shall be set to 2 (i.e. 16 bit short addressing).

The destination PAN identifier field shall contain the broadcast PAN identifier (i.e., 0xffff). The destination address field shall contain the short address of the destination, which is the target node in ranging process.

7.3.4.1.2 Forward preamble Ternary sequence identifier

This field specifies the Ternary sequence by which the preamble of the ranging data packet to be transmitted by the source shall be formed. The four octet long field enables an explicit identification of a length-31 sequence. If a look-up table is used, full length sequence does not have to be specified, but just 1-octet pointer to the sequence. This is more efficient, if the Ternary sequences are selected from a set in which the length of each sequence is 127.

7.3.4.1.3 Backward preamble Ternary sequence identifier

This field specifies the Ternary sequence by which the preamble of the ranging data packet to be transmitted by the target (e.g. acknowledgment) shall be formed. The four octet long field enables an explicit identification of a length-31 sequence. If a look-up table is used, full length sequence does not have to be specified, but just 1-octet pointer to the sequence. This is more efficient, if the Ternary sequences are selected from a set in which the length of each sequence is 127.

7.3.4.1.4 Ternary Sequence Length

This 1-bit field is set to 0 if length-31 sequences are to be used for ranging preamble and set to 1 if length 127 sequences are to be used.

7.4 MAC Constants and PIB Attributes

Table 86—MAC PIB attributes

Attribute	Identifier	Type	Range	Description	Default
...
<i>macAckWaitDuration</i>	0x40	List of Integer	38, 50, 54 or 120, ?	The maximum number of symbols to wait for an acknowledgment frame to arrive following a transmitted data frame. List of two values, second is optional. These values are dependent on the supported PHY, which determines both the selected logical channel and channel page and the used preamble length for ranging. The calculated values are time to commence transmitting the ACK plus the length of the ACK frame. The commencement time is described in 7.5.6.4.2. The first list value is used for the data service, the second for the ranging service.	Dependent on supported PHY and default ranging preamble length.
...
<i>macRangingSupported</i> [†]	0x60	Boolean	TRUE or FALSE	This indicates whether the MAC sublayer supports the optional ranging features*.	FALSE

Attribute	Identifier	Type	Range	Description	Default
<i>macRangingPreambleType</i>	0x61	Enumeration	TYPE_2, TYPE_3,...	Optional. The preamble type used for ranging.	TYPE_2
<i>macRangingSymbolLength</i>	0x62	Boolean	1 or 0	0 indicates the basis symbol for the preamble is length 31, otherwise length-127	TBD

*optional MAC ranging features: to be listed ...

....

Table 90— PIB security attributes

Attribute	Identifier	Type	Range	Description	Default
<i>macMPDUOffset</i>	0x7c	Integer	0x00-0xFF	Optional. Added delay of the MPDU for privacy on ranging. Implementation specific, minimum range is 300? ns, maximum step size is 3? ns.	0x00

7.5 MAC Functional Description

Insert the following after 7.5.7

7.5.7a Ranging

For ranging a data-acknowledgment frame sequence is utilized. Data and acknowledgment frames deliver timestamps at reception and transmission with high precision to the next higher layer. A higher layer or the application layer can calculate the distance from the time stamps of a data-acknowledgment round trip measurement. The calculation of distance or location of a radio is out of the scope of this standard and in responsibility of a higher layer. A ranging sequence is initiated by the higher layer through the MCPS-DATA request service primitive. In addition an acknowledged transmission must be requested through the service request. Both, the data and the acknowledgment frame utilized for ranging are ordinary MAC frames as used in MAC data service. Since ranging requires certain signal structures, the PHY frames of ranging sequences use different preamble types than ordinary data, acknowledgment, MAC command or beacon frames. The ranging support of the PHY is requested by the next higher layer above the MAC through an additional service type parameter. The information in this parameter is forwarded to the PHY, which in turn generates the PHY frames with the corresponding preamble. The service type of incoming frames is detected in the PHY, information is forwarded to the MAC and indicated to the next higher layer through the service type parameter of the MCPS-DATA indication primitive. The ranging frame sequence is not dedicated to ranging only, it may be utilized for additional data service between higher layers concurrently.

How ranging frame sequences are initiated, how ranging information is exchanged between ranging endpoints and other ranging specific protocol issues are out of the scope of this standard and in responsibility of a higher layer. This applies as well to the complete security and privacy mechanisms on ranging. However, MAC security features like encryption, replay protection and the MPDU offset may be utilized the by a higher layer for security and privacy on ranging.

7.5.7a.1 Classes of Service

Three classes of ranging service are supported in IEEE 802.15.4a: high accuracy ranging, fast ranging and cost effective ranging. The first two services are supported by coherent receivers. Non-coherent receivers only support the cost effective ranging.

7.5.7a.1.1 High Accuracy Ranging

The high accuracy ranging is referred to as a ranging accuracy of 10 cm at 50 meters in 8 milliseconds roundtrip time.

7.5.7a.1.2 Fast Ranging

The fast ranging is referred to as 10 cm accuracy at 20 meters in 1 milliseconds roundtrip time.

7.5.7a.1.3 Ranging with Non-coherent receivers

Ranging accuracy with coherent receivers is greater than that of non-coherent receivers. Cost effective ranging accuracy offered by non-coherent receivers is determined to be sub-meter, and it is highly dependent on receiver-end signal processing techniques.

7.5.7a.2 Message Timestamps

7.5.7a.3 Mitigation of relative crystal drift

The standard supports two ways to manage crystal drifts referred to as implicit and explicit approaches. In the explicit approach the receiving node determines the relative drift and reports it back to the original sender. The implicit approach is also known as the symmetric double sided two way ranging (SDS-TWR). In SDS-TWR, the two nodes take turn in initiating ranging with each other. The time stamps when subtracted in the proper order would eliminate relative crystal drift.

The goal of ranging is to determine the distance between two nodes. The purpose of positioning is to determine the position of a node in a network of nodes. Positioning, in simple words, utilizes triangulation using a number of estimated distances obtained through ranging measurements. The computational core of positioning is what is referred to as solver. One can think of the solver as a set of algorithms that work together to determine location. The goodness of the triangulation performed by the solver is heavily influenced by the quality of individual range measurements. Typically the solver assigns more weights to a more trustworthy measurement. The figure of merit is a measure of how worthy each ranging estimate is. Implementation of the solver is outside the scope of this standard. However, the standard does provide the figure of the merit to be used by solvers in any desired manner.

7.5.7a.4 Non-private ranging

This mode relies only on the existing MAC layer security mechanisms in IEEE 802.15.4a and does not require additional processing to enhance privacy of range measurements against malicious devices. Typically in TOA based ranging, the MAC layer of the originator (device A), generates a range-request primitive and passes it to the PHY layer. Then, the PHY transmits a ranging packet to a target node (device B). The range packet consists of a preamble, header and an encrypted payload; B performs acquisition and ranging on the ranging packet preamble. Then, the target MAC layer checks the authenticity of the source. If the ranging packet is identified to be from a legitimate source, a reply ranging packet is formed and transmitted and to the source.

Upon reception of the reply, the source A can track the round trip flight time and correspond it to a distance. Assume that the elapsed time between the departure time of A's signal and the arrival time of the reply from B at A is T_r . The time T_r can be approximated as $T_r = 2T_f + \tau_{ta}$, where T_f is the one-way time of flight of the signal and τ_{ta} is the turn-around time, i.e., the time between the reception timestamp of signal at B and the departure timestamp of reply from B. A key to ensure an accurate range estimate is to have a short τ_{ta} and to accurately measure it. Prolonging τ_{ta} would necessitate factoring in clock drifts into range estimates. Finally, the timestamp of the reception of the first ranging packet and

the timestamp of the departure of the second reply from the target are reported to the source in a separate packet by the target.

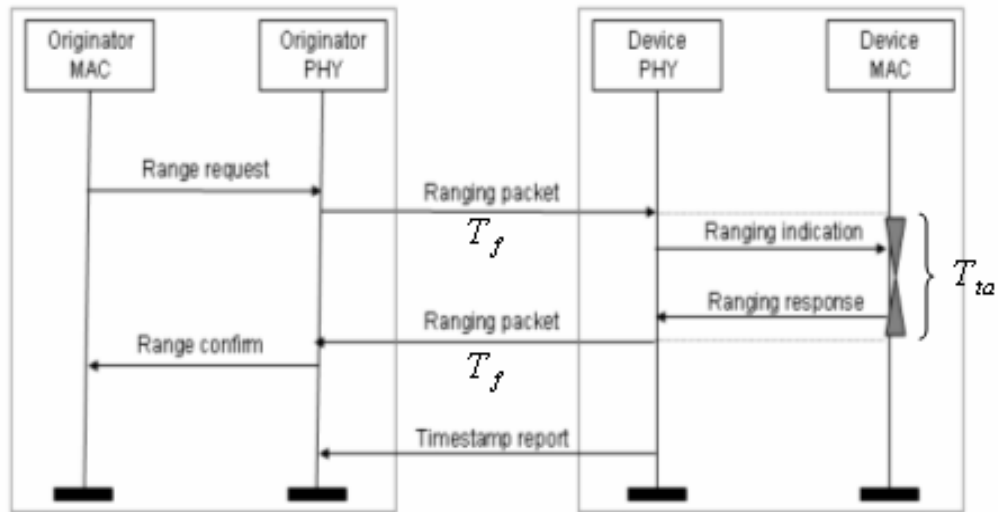

Figure 73a Illustration of typical ranging message exchanges between two ranging devices

7.5.7a.5 Private ranging

Ranging operations are vulnerable to attack for the purpose of fraudulent use and transmission interception. Data services can be protected by dedicated mechanisms which take place at higher layers. For instance, in IEEE Standard 802.15.4-2003 the MAC sub-layer is responsible for providing security services such as data encryption and frame integrity. However, ranging requires a protection on the PHY waveform to avoid potential acquisition by an unauthorized device.

Private ranging is an optional set of mechanisms which provide users with privacy in ranging operation. It aims to keep the measurements confidential and to prevent the user from attacks by malicious devices.

There are typically two motivations behind location related attacks. First, an intruder intends to figure out the location of sensor devices in a protected area and tries to tamper and disable them. In the latter, the intention is invisibly to be detrimental to a network. Relative positioning information in a network can be used to optimize high layer network operations such as route discovery and maintenance, multi-casting and broadcasting. If falsified position information is passed within the network, optimality of such network operations can be damaged. Malicious devices can be classified as snoopers, impostors and jammer.

A snoopers device within the ranging concept observes or listens to the signals in the air in secret to obtain information on whereabouts of other devices. By measuring signal strength of transmissions and the delay between a range request and a range response, a snoopers can have a coarse knowledge of its range to other devices.

An impostor device engages in deception under an assumed name or identity. By simply replaying originator's ranging message it can trigger a response at the target node and hence track the relative distance between them. In unsecure fast ranging networks, an impostor can impersonate target devices by transmitting a ranging reply before the target and cause the originator device to misread its range to the target.

A jammer device simply injects interference into the network and prevents neighboring devices from performing message exchanges. The most effective way to deal with a jammer is to back-off until it stops.

Also, advanced signal processing techniques at the receiver can be used to remove interference from the desired signal.

The IEEE 802.15.4a PHY provides hooks for implementing private-ranging mechanisms for variety of applications. Although this standard targets a diverse range of applications, a baseline implementation is required in the PHY to offer basic private-ranging services and interoperability among all devices.

The higher layer shall control the use of private ranging at the PHY layer and shall transfer the material required by the private-ranging services which have been specified.

The PHY layer is in charge of providing private-ranging services on specified ranging frames when requested by the higher layers. The IEEE Standard 802.15.4a supports the following private-ranging services: authentication, confidentiality and information hiding.

Depending on the mode in which the device is operating and the selected private-ranging suite, the PHY may provide different private-ranging services as explained below.

To deal with jamming and deceptive malicious devices, the Private ranging mode offers two defense mechanisms: dynamic selection of a ranging waveform for each ranging signaling and dithering of turn-around time.

7.5.7a.5.1 Dynamic preamble selection (DPS)

The set of ternary sequences to be used in ranging packet preambles is very small. For length 31 sequences, there exist only six codes with perfect periodic auto-correlation function, while there are only 92 of length 127 such Ternary sequences. If only one sequence from the set is dedicated to ranging, it becomes highly likely for a malicious device to track it. It can simply know what base sequence to track in the air. Furthermore, it can transmit the very same Ternary sequence into the air and those transmissions can be deceptive to legitimate ranging devices already expecting a ranging packet from their partners.

It is shown in simulations that if the Ternary sequences in the preamble of the ranging packets and the signal from a malicious device don't match each other, the detection of the leading edge and periodic auto-correlation peaks at legitimate receivers become easier. Otherwise, the signal from the malicious transmitter also causes the same perfect periodic auto-correlation peaks at legitimate receivers as the signals from desired ranging transmitters. Dynamic preamble selection for the preamble formation of the range packets lowers the likelihood that a malicious device will pick the same preamble sequence.

It is possible to improve the privacy level by selecting a different preamble base sequence for range packet to be transmitted from first device to the second and for that to be transmitted from the second to the first device as a reply.

7.5.7a.5.2 Dithering turn-around time

In two-way TOA, the second device receives a ranging packet from the first device; and then it returns a reply ranging packet. The time it elapses between the reception time of the range packet from the first device and transmission time of the reply range packet from the second device is referred to as "turn-around time".

As a privacy mechanism, if the second device simply dithers the turn-around time, any malicious device eavesdropping ranging packets in the air will be exposed to positive bias in its range estimates because of the dither amount unknown to the malicious device. How much to dither can be imposed on the second device by the first device, or simply the second device can delay the turn-around time itself and later on reports it to the first device. Note that it is harder for a device to track whether a predetermined turn-around time elapses. Therefore, the latter is preferred.

Assume that node A is to initiate a ranging process with node B. The DPS requires a range notification packet to be transmitted from the first device (A) to the second (B) prior to exchanging range packets. The

range notification packet is used to inform the second device of what Ternary sequences to use for the ranging packet preambles. Therefore, it should include a sequence identifier. Following the notification packet, the first device forms a ranging packet with a preamble constructed from the selected sequence, and sends the ranging packet to the second device. This ensures that the range packet is manipulated randomly by using different base sequence for each ranging packet.

The ranging packet consists of a preamble, header and a payload. The second device performs acquisition and leading edge detection on the preamble. It then, replies to the first device with a ranging packet with a preamble of the selected sequence after some delay time $\tau_{ra} + \Delta\tau_d$ that is known only to the first device and to the second device itself. The preamble sequence of the ranging packet by the first device may be different from that by the second device to increase privacy level.

The delay time can be either set by the first device and transmitted to the second device in an encrypted form in the range notification packet, or if the preference is for the second device to decide what the turn-around time dither $\Delta\tau_d$ would be, this information should be reported back to the first device after ranging packet exchanges are completed. The latter option is easier to implement and recommended over the first.

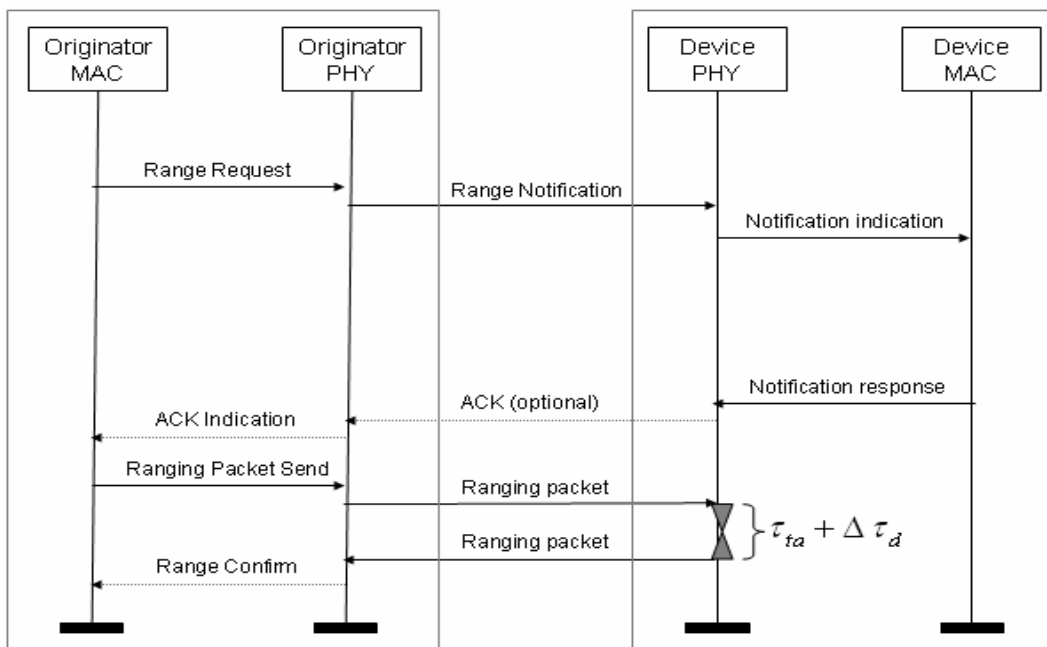

Figure 73b – {title}

The timestamp of the reception of the first ranging packet at the second device and the timestamp of the departure of the second reply from the second device are reported to the first device in a separate packet by the target. Hence, the dither duration becomes factored into the time-stamps.

7.5.7a.6 MAC command to initiate two way ranging

Range notification command is used to initiate two-way ranging.

7.5.7a.7 The two-way ranging initiate packet

The two-way ranging initiate packet is prepared by the ranging originator. If a range notification command is transmitted before this initiate packet; and the sequence identifier and its length given in the range

notification packet are different from their default, those should be used to form a preamble of the ranging initiate packet.

7.5.7a.8 The two-way ranging response packet

The two-way ranging response packet is a conventional ACK packet specified in IEEE 802.15.4b specifications. However, its preamble length should be one of the specified in Table xxx. During private ranging, the preamble of the ACK is formed from the sequence corresponding to the one given in "backward preamble Ternary sequence identifier" field of the range notification packet. If not private ranging, the preamble is formed by using the default length-31 sequence.

7.5.7a.9 Timestamp report message

The time stamp report is sent by a ranging target to the ranging source following ranging transaction packet exchange. Both coordinators and RFDs should be capable of sending this command. The target device that transmits a two-way ranging response packet, after transmission of the response packet forms and transmits a timestamp report message to the originator. The structure of the timestamp report message is illustrated in Figure 73c.

Octet 17/23	1	4	4	3	b1 b0
MHR Fields	Command frame identifier (see Table 82)	Time Stamp	Tracking length	FOM /Tracking offset	Ranging Grade and Confidentiality

Figure 73c Time stamp report command format

7.5.7a.9.1 Time stamp

The total reply time of the target node is reported to the source in this field. A 32 bit field is allocated to this quantity.

7.5.7a.9.2 Tracking length

The total tracking delay of the target node is reported to the source in this field. A 32 bit field is allocated to this quantity.

7.5.7a.9.3 Tracking offset and figure of merit (FOM)

Tracking offset communicates the crystal offset information. Figure of merit (FOM) reflects the confidence in the accuracy of the extracted leading edge. FOM and crystal tracking offset are 5 and 19 bits wide, respectively. Altogether they require 3 bytes of information.

7.5.7a.9.4 Ranging grades and confidentiality

The bit b0 dedicated to "Ranging Grade" and the bit b1 is dedicated to state "Confidentiality". Ranging target can selectively degrade the time stamp provided to the source. Standard supports two grades of ranging accuracy defined as accurate or partially accurate. As such only one bit is allocated for this field in the time stamp report. "Accurate" is the default mode and set to 0. In the "degraded" mode, the target sets b0 to 1. Ranging target can request the source to treat its ranging information confidential or non-confidential. As such this field requires just one bit. The default mode is non-confidential. Hence, in the default mode b1 shall be set to 0 and 1 otherwise.

7.5.7b UWB option management

7.5.7b.1 Data rates

UWB PHYs optionally support multiple data rates as defined in {ref to 6.xxx}. A mandatory rate as defined in {reference 6.xxx} shall be present in all UWB PHYs. A PAN established at the mandatory rate may elect to operate with optional data rates. Table ccc defines this operation.

Table ccc – UWB data rate operation

		Mandatory operation		Optional low rate operation				
		PHR	PSDU	PHR	PSDU			
Coordinator traffic		base	base	Low base	Low base			
Initial		base	base	base	base			
App negotiated		base	All rates	Low base	Low base			

Methods for managing rates are left for higher layer protocols and are outside of the scope of this amendment.

Annex C

(normative)

Protocol implementation conformance statement (PICS) proforma

{use the following as the template for new tables or row additions to existing tables in this annex

Item number	Item description	Reference	Status	N/A	Support	
					Yes	No

}

C.7 PICS proforma tables

C.7.2.3 RF

Insert the following rows at the end of Table C.4—RF

Table C.4--RF						
Item number	Item description	Reference	Status	N/A	Support	
					Yes	No
RF3	2450 MHz CSS PHY	6.5a	O.3			
RF4	3100 to 10000 MHz UWB PHY	6.8a	O.3			
RF4.1	Low band 1		O			
RF4.2	Low band 2		M			
RF4.3	Low band 3		O			
RF4.4	Low band wide		O			
RF4.5	High band 1		O			
RF4.6	High band 2		O			
RF4.7	High band 3		O			
RF4.8	High band 4		O			
RF4.9	High band 5		O			

{add additional sub-clauses and tables for additional optional behaviors.
Preambles, data rates, pulse shapes for radios and ranging for MAC/PHY}

Insert the following after Annex D

Annex D1 (informative) Location Topics for use of the IEEE 802.15.4a standard

This document provides supplemental information to the standard in the application of parameter estimation to render location services. This information refers to techniques and algorithms to reconstruct the location of devices in a network from range (or direction) data between units. It also considers implementation issues such as leading-edge detection and the error induced by drift in timing crystal offsets. This first draft simply outlines the topics covered in the informative annex, each section bearing descriptive text which will be replaced in future versions with detailed explanation, figures, examples, etc. These have not been included in the draft version due to the imposed size quotes. Moreover, the draft offers the group members the opportunity to recommend additional text in this annex.

D1.1 Parameter (Range or Direction) Estimation Techniques

D1.1.1 Range Estimation

D1.1.1a Time-of-Arrival (TOA)

Time-of-arrival estimation yields the time elapsed for a signal to propagate from a transmitter to a receiver. Given this time and the speed of propagation, the distance, or *range*, between the two devices can be estimated. In consequence, given the locations of three anchor transmitter devices in a two-dimensional reference coordinate system and the respective ranges between those devices and a mobile receiver device, the three ranges can be *triangulated* through simple geometry to render the location of the latter in the same coordinate system: each stationary, or *anchor*, device sits at the center of a circle whose radius is equal to the range. The intersection of the three circles resolves the mobile location. (Three-dimensional location necessitates four transmitter devices and respective ranges.)

Ranging schemes to extract the TOA vary mainly according with respect to inter-device synchronization, but to communication protocol and network topology, as shown in the sequel.

D1.1.1a.1 Synchronous one-way ranging (OWR)

(From Doc. 15-04/0581r7)

The one-way ranging scheme operates under the assumption that the two ranging devices are synchronized a priori to a common clock. This enables the receiver device to easily correlate the received signal with the known transmitted sequence to estimate the TOA as the time of maximum correlation.

Now, if two terminals are synchronized to a common clock (i.e. sharing the same time reference and time base), it is clear that the TOF information can be directly obtained from a simple OWR transaction.

The two previous transactions provide so-called TOA location metrics corresponding to the relative distance between terminals. For the considered scenarios (TOA/TWR and TOA/OWR), slot lengths and procedures, fixed by a pre-existing communication standard, represent drastic constraints for the maximum and minimum (blind distances) relative measurable distances and the ranging accuracy.

D1.1.1a.2 Asynchronous two-way ranging (TWR)

(from Doc. 15-04/0581r7)

Two-way ranging enables measuring the signal round-trip propagation time t_p between two asynchronous transceivers through a classical two-way remote synchronization technique. A pair of terminals are time-multiplexed with half-duplex packet exchanges. This procedure relies on a typical mechanism for fused location and communication: a transmitter (TX) sends a packet to a receiver (Rx) which replies after waiting a nominal period $t_{\text{delay}}^{\text{RX}}$ necessary for synchronizing with packets containing synchronous timing information. The reception in turn of this response allows the transmitter to determine the round-trip information as $t_{\text{round}}^{\text{TX}} = 2t_p + t_{\text{delay}}^{\text{RX}}$. The propagation time can be extracted from this equation given the measured value of $t_{\text{round}}^{\text{TX}}$ and $t_{\text{delay}}^{\text{RX}}$. This solution seems to be particularly adapted for distributed networks (a fortiori in the lack of coordination).

D1.1.1a.3 Asynchronous symmetric doubly-sided two-way ranging (SDS-TWR)

(from Doc. 15-05/-0335r0)

This section proposes an improvement to the two-way ranging scheme described in the previous, however at the price of an additional message in the exchange between two ranging devices. The protocol operates in the following manner: the transmitter sends a ranging request to the receiver which arrives after a propagation time t_p . RX waits a nominal period $t_{\text{delay}}^{\text{RX}}$, and then itself sends a ranging request to the transmitter after yet another t_p , formulating the round trip to the transmitter as $t_{\text{round}}^{\text{TX}} = 2t_p + t_{\text{delay}}^{\text{RX}}$. After the transmitter computes its round trip time, it sends yet another range request to the receiver, so that the latter too can compute its round-trip time $t_{\text{round}}^{\text{RX}} = 2t_p + t_{\text{delay}}^{\text{TX}}$. Combing the equations for $t_{\text{round}}^{\text{TX}}$ and $t_{\text{round}}^{\text{RX}}$, the propagation time $t_p = [(t_{\text{round}}^{\text{TX}} - t_{\text{delay}}^{\text{TX}}) + (t_{\text{round}}^{\text{RX}} - t_{\text{delay}}^{\text{RX}})]/4$ can be extracted. This approach has precision advantages with respect to the simple TWR when considering the finite tolerance of the timing crystals of the devices. Such advantages are evidenced in Section D1.4.2.

D1.1.1b Time-Difference-of-Arrival (TDOA)

(from Doc. 15-04/0581r7)

Time-difference-of-arrival is related to TOA inasmuch as the time difference between synchronized reference anchor terminals is calculated and used for the localization calculations. The TDOA is traditionally obtained through OWR transactions. In this scheme, a pair of isochronous terminals, viewed as anchors, preliminarily detect the TOA associated with packets emitted by the mobile. The TOAs are estimated relative to a common reference time (shared among references) but independent on the actual transmission time.

Anchors have to be re-synchronized with an external clock or by a beacon signal periodically broadcasting packets to all the fixed references. This beacon signal may come from a coordinator or a dedicated terminal. Note that “synchronization” means “absolute synchronization” here, and implies that anchors know their relative distance to the beacon provider.

Finally, the approach taken to calculate the position of a mobile terminal for TDOA location metrics involves making two or more TDOA measurements. A straightforward approach uses a geometric interpretation to calculate the intersection of two or more hyperbolas for TDOA-based algorithms. If two or more TDOA measurements can be formed at a set of three or more distinct anchors, the mobile position can be easily computed in the 2-D plane.

Note that the basis for TDOA is one-way ranging (OWR). The implementation of OWR can be done in one of two forms; that is, either active OWR where the unknown station is transmitting or passive where the unknown stations is receiving. The primary implication is where the TDOA hyperbolas are collected for processing.

D1.1.1c Time Sum of Arrival (TSOA)

(To be completed.)

D1.1.1d Signal Strength Ranging (SSR)

(from Doc. 15-04/0581r7)

SSR ranging is already supported by the 802.15.4 standard because it runs off the RSSI. SSR ranging is simple and does not require the synchronization needed for TOA and TDOA based ranging; however, there are issues with attenuation variance due to multipath, etc, which require multiple measurements and measurement averaging.

We start our analysis by considering the case of free space propagation. In free space propagation, the received power, as a function of distance, is given as $P_r(d) = P_t G_t G_r \left(\frac{\lambda}{4\pi d}\right)^2$ Watts. In free space, the “large-scale” energy attenuation obeys an inverse square law relationship

$L(d) = 10 \log 10 \left(\frac{P_r}{P_t}\right) = 10 \log 10 \left(\frac{(4\pi d)^2}{G_t G_r \lambda^2}\right)$. In practice, the far field received power is reference to a

distance d_0 as $P_r(d) = P_r(d_0) \left(\frac{d_0}{d}\right)^2$. In terrestrial settings, additional mechanisms such as reflection, diffraction and scattering affect wave propagation and causing “small-scale” slow and fast fading components. For ranging we’d like to extract the large-scale attenuation from the combined large and small scale attenuation.

With wideband signals the mean received power can be calculated by summing the powers of the multipath in the power delay profile. With narrowband signals, received power experiences large fluctuations over a local area and averaging must be used to estimate the mean received power. Range can be estimated via

$\hat{d} = d_0 10^{\frac{p_0 - \hat{p}(d)}{10n}} = d 10^{\frac{X_\sigma}{10n}}$. The range estimation distribution variance decreases with decreasing distance.

(While Rick Roberts and the ranging subcommittee did an excellent job of describing this technique, it does not seem to have much application in the standard given the high-frequencies in the band of interest (3-10GHz), and in turn the very limited (sub-meter) range the NFER offers.)

D1.1.2 Direction Estimation: Angle-of-Arrival (AOA)

(from Doc. 15-04/0581r7)

As opposed to estimating the range between two devices as a parameter for location, angle-of-arrival techniques estimate the direction between the two instead with respect to a reference coordinate system. The main advantage offered by this technique relaxes the requirement of pinpoint synchronization between the two devices, and when combined with a viable ranging technique, AOA allows vector ranging which opens up interesting possibilities. However in general this technique yields inferior location precision with respect to range-estimation techniques.

The angle of arrival is the direction to the source of an incoming wave field as measured by an array of antenna elements. The planar wave front models the incoming wave far field by measuring the phase

(time) difference of the wave front at different array elements⁵. A phased array antenna system consists of any number of antenna elements distributed in a particular geometrical pattern, with the output of all the antenna elements vectorially added to synthesize a particular antenna pattern in the direction of the incoming source fields.

As long as the spatial sampling requirement is met⁶, larger arrays generally provide better resolution of the source field, but with increasing size and cost. In the case of UWB, the maturity of UWB antenna array technology must be taken into consideration.

Special consideration is needed for multipath environments and for multi-source cases since sources can be closely spaced. In non-line-of-sight environments, the measured AOA might not correspond to the direct path component of the incoming wave field which can lead to large positioning errors.

Two dimensional positioning requires measurement of the AOA by at least two antenna array systems. In practice, measurement errors arise due to: imperfect array phase and gain calibration, improper modeling of the mutual coupling between elements, and error due to the presence of a strong indirect path.

D1.1.3 Combined Range and Direction Estimation

To be completed.

D1.2 Location Estimation Algorithms

D1.2a Location Estimation from Range Data

Given a network consisting of fully-functioning devices (FFD) (of which at least three serve as anchor devices in a two-dimensional network) and reduced-functioning devices (RFD), and a set of estimated ranges between neighboring devices in the network, estimate the locations of the unknown mobile devices in the network.

D1.2a.1 Isolating outliers in the range data

To be completed.

D1.2b Location Estimation from Direction Data

Given a network consisting of fully-functioning devices (FFD) (of which at least two serve as anchor devices in a two-dimensional network) and reduced-functioning devices (RFD), and a set of estimated directions between neighboring devices in the network, estimate the locations of the unknown mobile devices in the network.

D1.3. Leading Edge Detection

⁵ Whether or not the far-field planar wave approximation holds well will depend on the array aperture and the minimum wavelength of the source signal. In the near field, the phase (time) difference at different array elements becomes a non-linear function of the source's position.

⁶ There is a spatial sampling requirement that limits the inter-element spacing of antenna elements to be $\leq \frac{1}{2}$ minimum source wavelength.

D1.3.1 Coherent delay estimation with low sampling rate and feasible ADC implementation

(from Doc. 15-05/0524r1)

The conventional approach to leading-edge detection first correlates, through analog technology, the known sequence with the sequence detected at the receiver, applying an analog-to-digital converter only after the code correlator. A more efficient approach in terms of complexity first samples the received sequence through an analog-to-digital converter, and then through these samples performs correlation through digital technology. The propagation time measured between the transmitted and received signals is reconstructed from these samples using a polynomial interpolation.

D1.3.2 A First-arrival Detection Method

(from Doc. 15-05/0406r0)

In most cases the correlation profile computed at the receiver consists of multiple peaks, each from a separate arrival path. In non-line-of-sight conditions, the leading edge is rarely the strongest of the peaks. The proposed leading-edge detector proceeds in an iterative fashion, detecting the relatively largest peak in the profile through the method described in D1.3.1, and subsequently eliminating both it and the ones associated with a greater delay than its own. Only one peak will remain after sequentially eliminating all the other peaks: the leading-edge peak.

D1.4 Error Induced by Timing Crystal Offset

D1.4.1 The effect on the preamble and channel-sounding segments

(from Doc. 15-05/0335r1)

The proposed lengths for the preamble and channel-sounding segments of the packet are 128 and 1024 pulses respectively. Consider first correlating the channel-sounding segment of the known pseudo-random sequence with the received sequence. The pulse width corresponding to a 500MHz frequency limited signal is 5ns and the pulse-event repetition rate is 430ns according the standard. It takes 0.44ms to integrate across the 1024 pulses in the channel-sounding segment, and in the worst case for which there is a X (ppm) drift factor in the crystal at the start of integration and a -X (ppm) factor by the end, robustness to noise necessitates a X=2.5 tolerance crystal such that the total drift (0.44ms x 2X) does not exceed 2.2ns, or about half of the pulse width, such that the integration remains concentrated at the center of the pulse.

Crystals of a lesser precision require a tracking circuit for the channel-sounding segment { (Doc. 15-05/0246r1)} to manage this drift to an acceptable level. However the preamble segment, where acquisition occurs, cannot be tracked as the former since the signal has not yet been locked on. Using the same argument as for the channel-sounding segment, X=20 suffices for the preamble segment. So ultimately the preamble segment determines the minimum acceptable tolerance of the device clocks.

D1.4.2 The effect on the ranging accuracy

Ranging using the TWR (section D1.1.1a.2) reduces the propagation time to $t_p = (t_{\text{round}}^{\text{TX}} - t_{\text{delay}}^{\text{RX}})/2$, where the first term is measured with the crystal tolerance of the transmitter X^{TX} and the second with the crystal tolerance X^{RX} of the receiver, for a worst-case drift of $(t_{\text{round}}^{\text{TX}} X^{\text{TX}} + t_{\text{round}}^{\text{RX}} X^{\text{RX}})/2$. Since $t_{\text{round}}^{\text{TX}}$ and $t_{\text{round}}^{\text{RX}}$ are relatively large numbers with respect to t_p , this drift could be significant.

Consider rather ranging using the SDS-TWR (section D1.1.1a.2) which reduces the propagation time to $t_p = [(t_{\text{round}}^{\text{TX}} - t_{\text{delay}}^{\text{TX}}) + (t_{\text{round}}^{\text{RX}} - t_{\text{delay}}^{\text{RX}})]/4$, for a worst-case drift of $[(t_{\text{round}}^{\text{TX}} - t_{\text{delay}}^{\text{TX}}) X^{\text{TX}} + (t_{\text{round}}^{\text{RX}} - t_{\text{delay}}^{\text{RX}})]/4$.

$X^{RX}/4$. Since $(t_{\text{round}}^{\text{TX}} - t_{\text{delay}}^{\text{TX}}) \ll t_{\text{round}}^{\text{TX}}$ and $(t_{\text{round}}^{\text{RX}} - t_{\text{delay}}^{\text{RX}}) \ll t_{\text{round}}^{\text{RX}}$, the drift for SDS-TWR is significantly reduced with respect to the drift for TWR.

This section will also include results presented on the SDS-TWR drift from the analysis conducted by Emami, Corral, and Razor at Freescale using $X=10$ and $X=40$.

Annex E (informative) Coexistence with other IEEE standards and proposed standards

While not required by the specification, IEEE 802.15.4 devices can be reasonably expected to “coexist,” that is, to operate in proximity to other wireless devices. Sections E.1 to E.4 of this annex considers issues regarding coexistence between IEEE 802.15.4 devices and other wireless IEEE-compliant devices. These sections also consider issues regarding coexistence between IEEE P802.15.4a CSS devices and other wireless IEEE-compliant devices.

Insert the following text in the introduction

With more and more radio services using the spectrum, coexistence is becoming a key issue. IEEE 802.19 TAG established some new procedures in 2005 which include the requirement for a Coexistence Assurance document from any IEEE 802 WG or TG drafting a new standard. Added sections in the present Annex addresses (sections E5 to E10) the coexistence between UWB 802.15.4a devices and other wireless IEEE-compliant devices.

E.1 Standards and proposed standards characterized for coexistence with IEEE 802.15.4 and 802.15.4a CSS devices

Add the following text at the end of E.1:

This clause also enumerates IEEE-compliant devices that are characterized and the devices that are not characterized for operation in proximity to IEEE P802.15.4a CSS devices.

IEEE P802.15.4a CSS PHYs for ISM Band are specified for operation in 14 channels. Channel 0 through channel 14 resides in frequencies from 2412 MHz to 2484 MHz bands and, therefore, may interact with other IEEE compliant devices operating in those frequencies.

Standards and proposed standards characterized in this annex for coexistence are
 IEEE Std 802.11b-1999 (2400 MHz DSSS)
 IEEE Std 802.15.1-2002 [2400 MHz frequency hopping spread spectrum (FHSS)]
 IEEE Std 802.15.3-2003 (2400 MHz DSSS)
 IEEE Std 802.15.4-2003
 IEEE P802.15.4a

Standards not characterized in this annex for coexistence are:
 IEEE Std 802.11, 1999 Edition, frequency hopping (FH) (2400 MHz FHSS)
 IEEE Std 802.11, 1999 Edition, infrared (IR) (333GHz AM)
 IEEE Std 802.16-2001 (2400 MHz OFDM)
 IEEE Std 802.11a-1999 (5.2GHz DSSS)

E.2 General coexistence issues for IEEE 802.15.4 and 802.15.4a CSS devices

Add the following gsection after E.2.6:

E.2.6a Channel alignment

The alignment between IEEE 802.11b (nonoverlapping sets) and IEEE P802.15.4a CSS channels (overlapping sets) are shown in Figure E.2.6.1. There are 14 IEEE P802.15.4a CSS channels ($n = 1, 2, \dots, 14$). Operating an IEEE P802.15.4a network on one of these channels will minimize interference between systems.

When performing dynamic channel selection, either at network initialization or in response to an outage, an IEEE P802.15.4a CSS device will scan a set of channels specified by the ChannelList parameter. For IEEE

P802.15.4a networks that are installed in areas known to have high IEEE 802.11b activity, the ChannelList parameter can be defined as the above sets in order to enhance the coexistence of the networks.

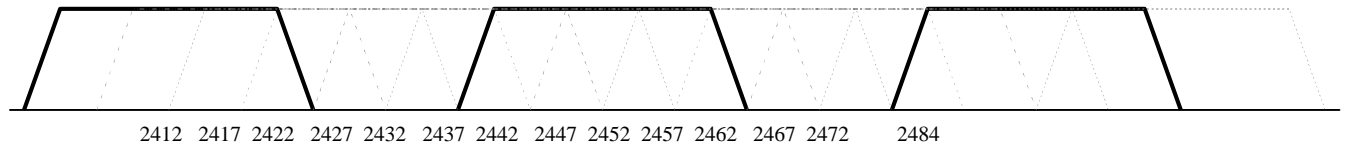

Figure E.2.6.1— IEEE P802.15.4a CSS channel selection

E.3 Coexistence performance for IEEE 802.15.4 and 802.15.4a CSS devices

The assumptions made across all standards characterized for coexistence are described in E.3.1. Subclauses E.3.2 and E.3.3 describe the assumptions made for individual standards and quantify their predicted performance when coexisting with IEEE 802.15.4 devices.

Add the following sentence :

Subclauses E.3.2 and E.3.3 also describe the assumptions made for individual standards and quantify their predicted performance when coexisting with IEEE P802.15.4a CSS devices.

E.3.1 Assumptions for coexistence quantification

E.3.1.1 Channel model

E.3.1.2 Receiver sensitivity

Add the following text to E.3.1.2:

The receiver sensitivity assumed is the reference sensitivity specified in each standard as follows:

- 76 dBm for IEEE 802.11b 11 Mb/s CCK
- 70 dBm for IEEE 802.15.1
- 75 dBm for IEEE P802.15.3 22 Mb/s DQPSK
- 85 dBm for IEEE 802.15.4
- 80 dBm for IEEE 802.15.4a 1Mb/s CSS
- 87 dBm for IEEE 802.15.4a 1Mb/s CSS

E.3.1.3 Transmit power

Add the following text to E.3.1.3:

The transmitter power for each coexisting standard has been specified as follows:

- 14 dBm for IEEE 802.11b
- 0 dBm for IEEE 802.15.1
- 8 dBm for IEEE 802.15.3
- 0 dBm for IEEE 802.15.4
- 0 dBm for IEEE P802.15.4a (both 1Mb/s and optional 250Kb/s)

E.3.1.4 Receiver bandwidth

The receiver bandwidth is as required by each standard as follows:

- a) 22 MHz for IEEE 802.11b
- b) 1 MHz for IEEE 802.15.1
- c) 15 MHz for IEEE P802.15.3
- d) 2 MHz for IEEE 802.15.4

Add the following bullet to the list :

- e) 22 MHz for IEEE P802.15.4a

E.3.1.5 Transmit spectral masks

Add the following Table :

Table E.3.1.5.1—Transmit mask for IEEE P802.15.4a CSS

Frequency	Relative limit
$f_c - 22 \text{ MHz} < f < f_c - 11 \text{ MHz}$ and $f_c + 11 \text{ MHz} < f < f_c + 22 \text{ MHz}$	-30 dBr
$f < f_c - 22 \text{ MHz}$ and $f > f_c + 22 \text{ MHz}$	-50 dBr

E.3.1.6 IEEE 802.11b transmit PSD**E.3.1.7 Interference characteristics****E.3.1.8 Bit error rate (BER) calculations**

Add the following bullet :

$$8) \text{ BER for IEEE 802.15.4a CSS} = \left[(M - 2) \times Q(\sqrt{SINR}) + Q(\sqrt{2 \times SINR}) \right] / 2$$

where $M = 8$ for 1 Mb/s, and $M = 64$ for optional 250 kb/s.

E.3.1.9 PER

Add the following bullet :

- e) Average frame length for IEEE P802.15.4a CSS = 32 bytes

E.3.2 BER model

This subclause presents the BER for standards characterized for coexistence. The BER results were obtained using the analytical model from IEEE P802.15.2. The calculation follows the approach outlined in 5.3.2 of that document and the conversion from SNR to BER uses the formulas in 5.3.6 of that document. Figure E.2 illustrates the relationship between BER and SNR for IEEE 802.11b, IEEE 802.15.3 base rate, IEEE 802.15.1, and IEEE 802.15.4.

Modify the numbering of Figure E.2 mentioned above to Figure E.3.2.1, and add the following text :

Figure E.3.2.2 illustrates also the relationship between BER and SNR for IEEE 802.11b, IEEE 802.15.3 base rate, IEEE 802.15.1, IEEE 802.15.4, and IEEE P802.15.4a CSS.

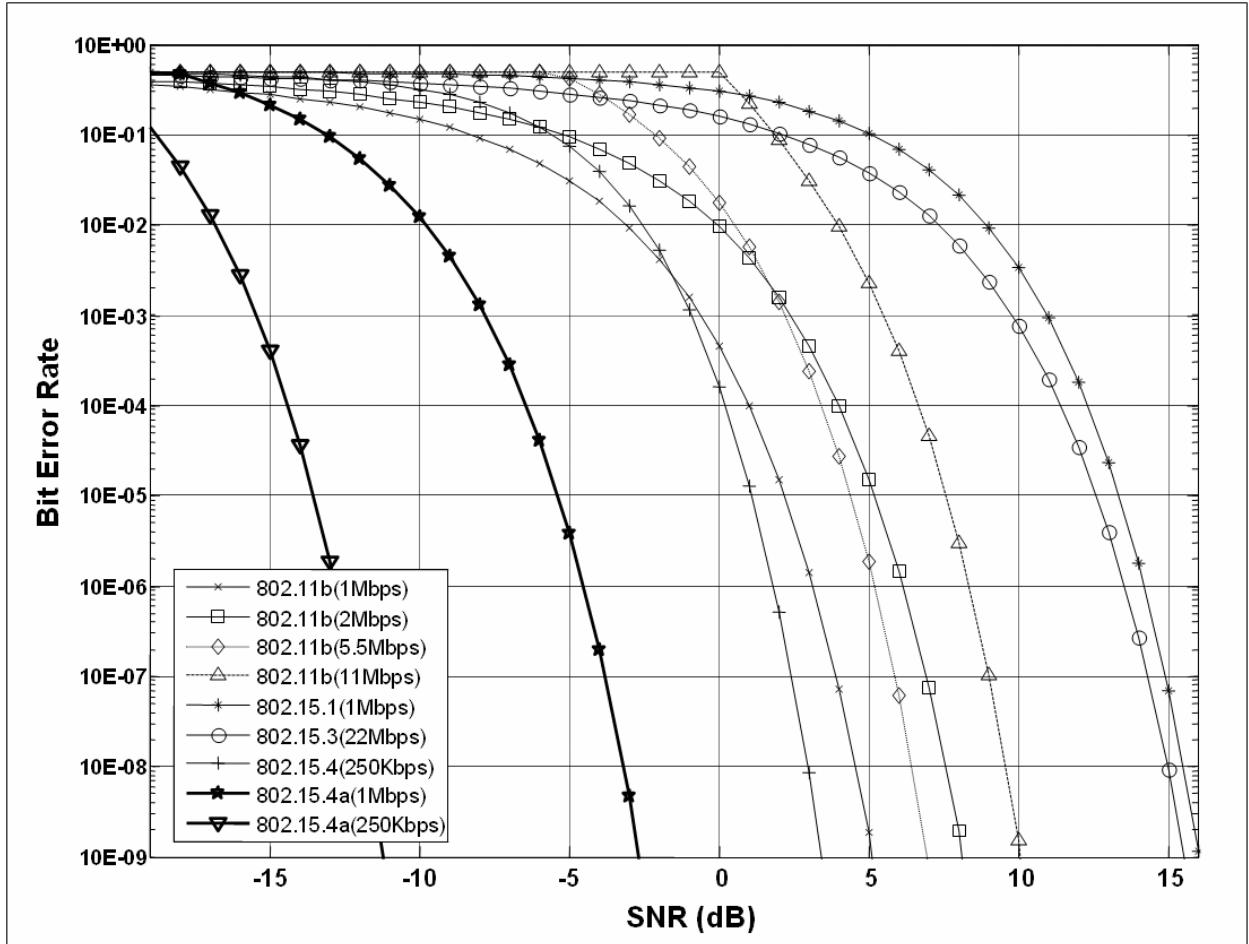

Figure E.3.2.2—BER Results of IEEE 802.11b, IEEE 802.15.1, IEEE 802.15.3, IEEE 802.15.4 (2400 MHz PHY) and IEEE P802.15.4a CSS

E.3.3 Coexistence simulation results

Modify "E.3.3.1 Transmit and receive masks" as follows :

The transmit and receive masks used are defined in Table E.3.3.1

Table E.3.3.1 – Transmit and receive masks

IEEE802	Transmit		Receive	
	Frequency offset (MHz)	Attenuation (dB)	Frequency offset (MHz)	Attenuation (dB)
15.1	0	0	0	0
	0.25	0	0.25	0
	0.75	38	0.75	38
	1	40	1	40
	1.5	55	1.5	55
11b	0	0	0	0
	4	0	4	0
	6	10	6	10
	8	30	8	30
	9	55	9	55
15.4	0	0	0	0
	0.5	0	0.5	0
	1	10	1	10
	1.5	20	1.5	20
	2	25	2	25
	2.5	30	2.5	30
	3	31	3	31
	3.5	33	3.5	33
	4	34	4	34
	5	40	5	40
	6	55	6	55
15.4a - CSS	0	0	0	0
	6	0	6	0
	12	32	12	32
	15	55	15	55

Add the following graphs :

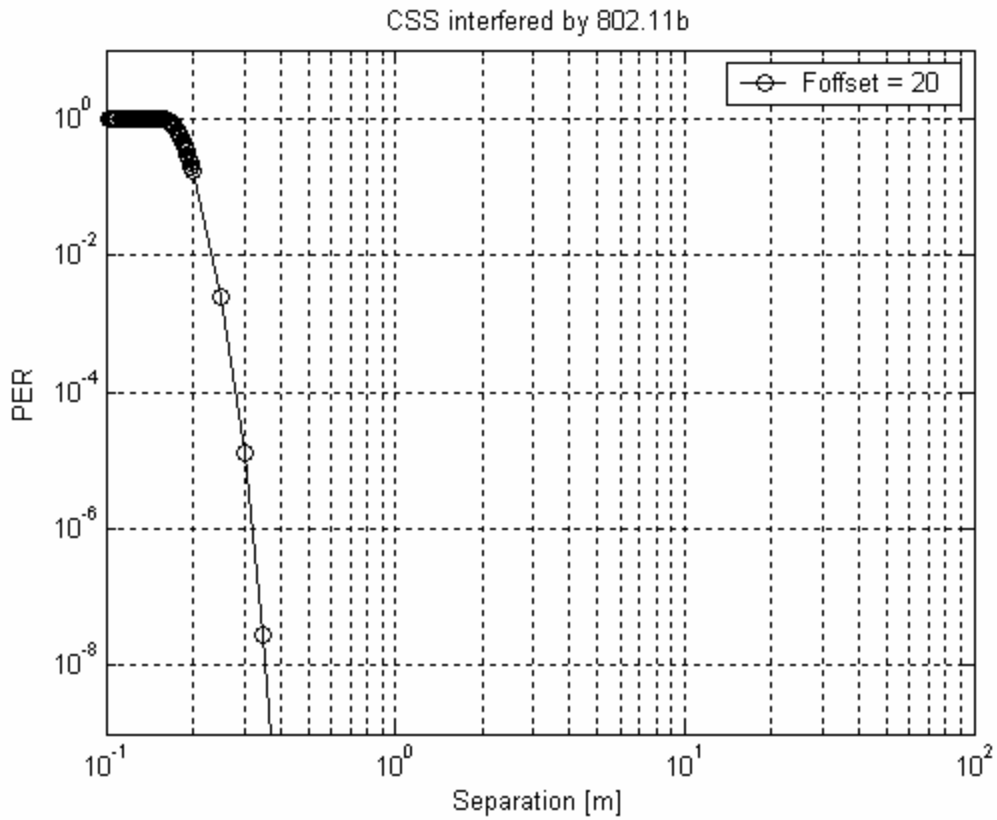

Figure E.3.3.1 —IEEE P802.15.4a CSS receiver (1Mbps), IEEE 802.11b interferer

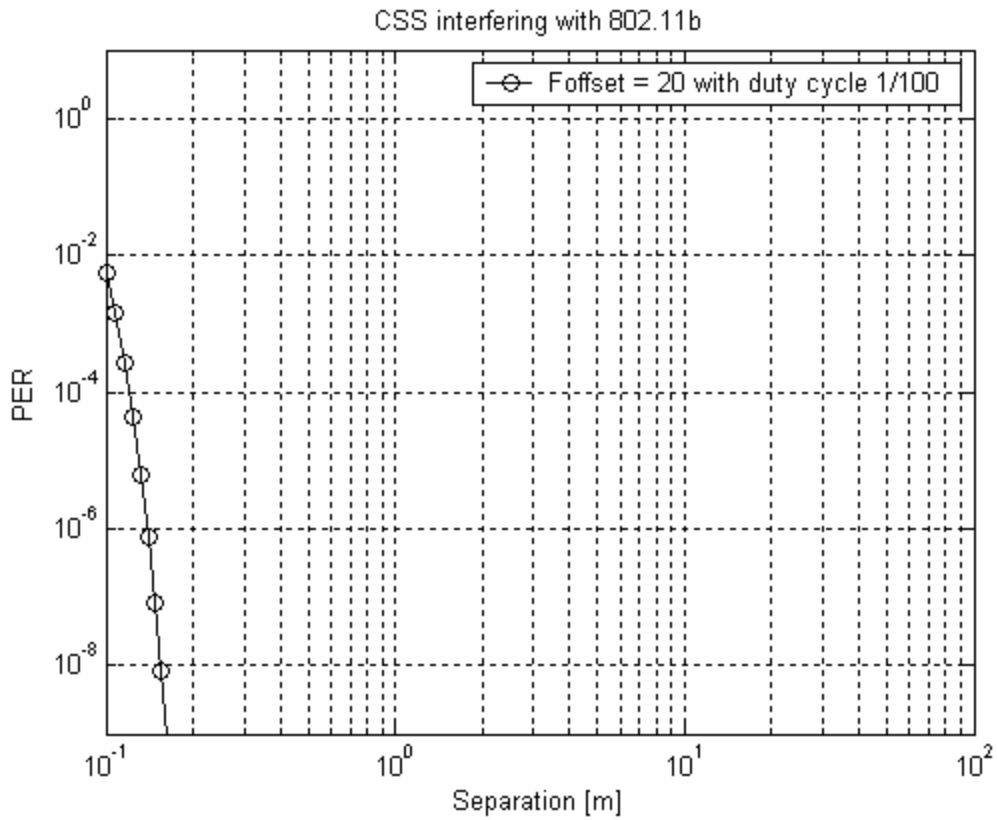

Figure E.3.3.2—IEEE 802.11b receiver, IEEE P802.15.4a CSS interferer

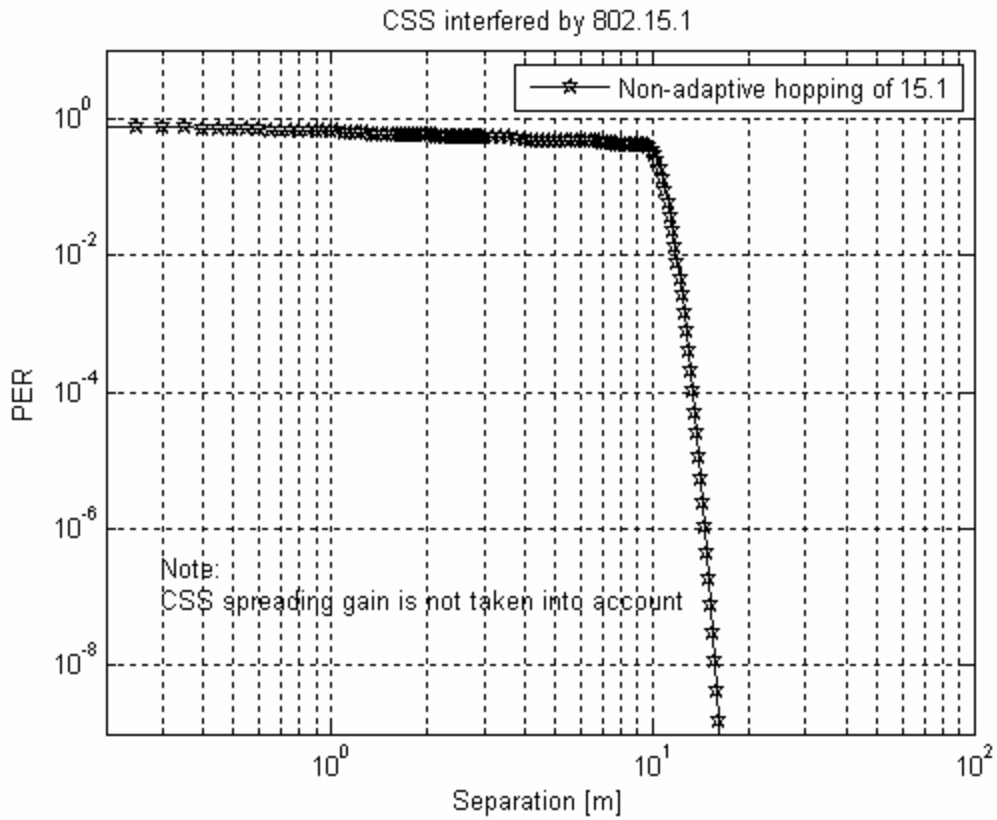

Figure E.3.3.3 —IEEE P802.15.4a CSS receiver (1Mbps), IEEE 802.15.1 interferer

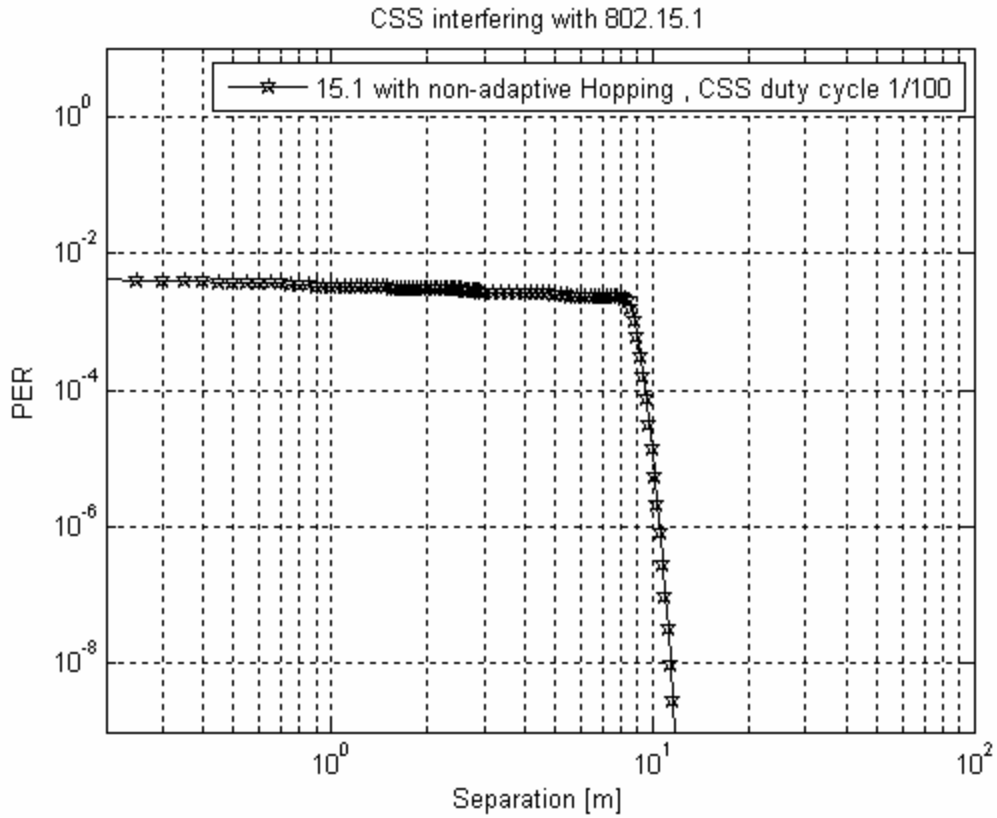

Figure E.3.3.4—IEEE 802.15.1 receiver, IEEE P802.15.4a CSS interferer

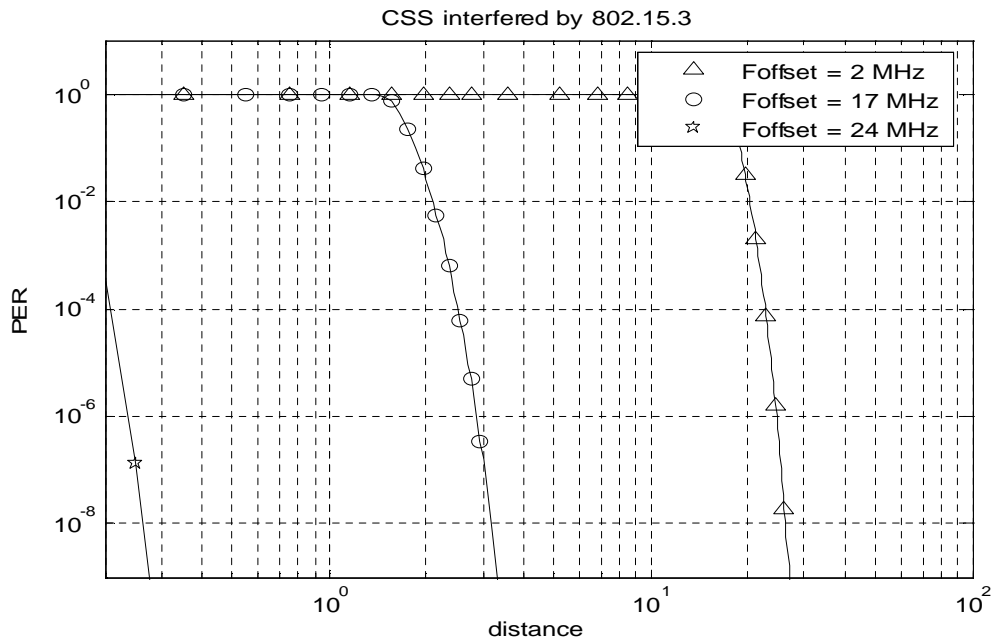

Figure E.3.3.5—IEEE P802.15.4a CSS receiver (1Mbps), IEEE 802.15.3 interferer

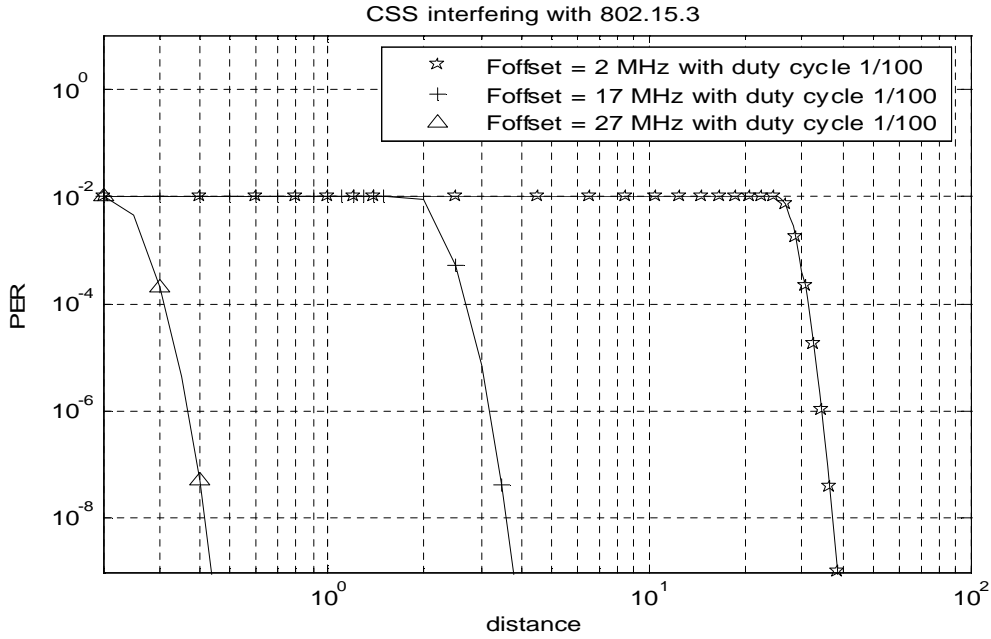

Figure E.3.3.6 —IEEE 802.15.3 receiver, IEEE P802.15.4a CSS interferer

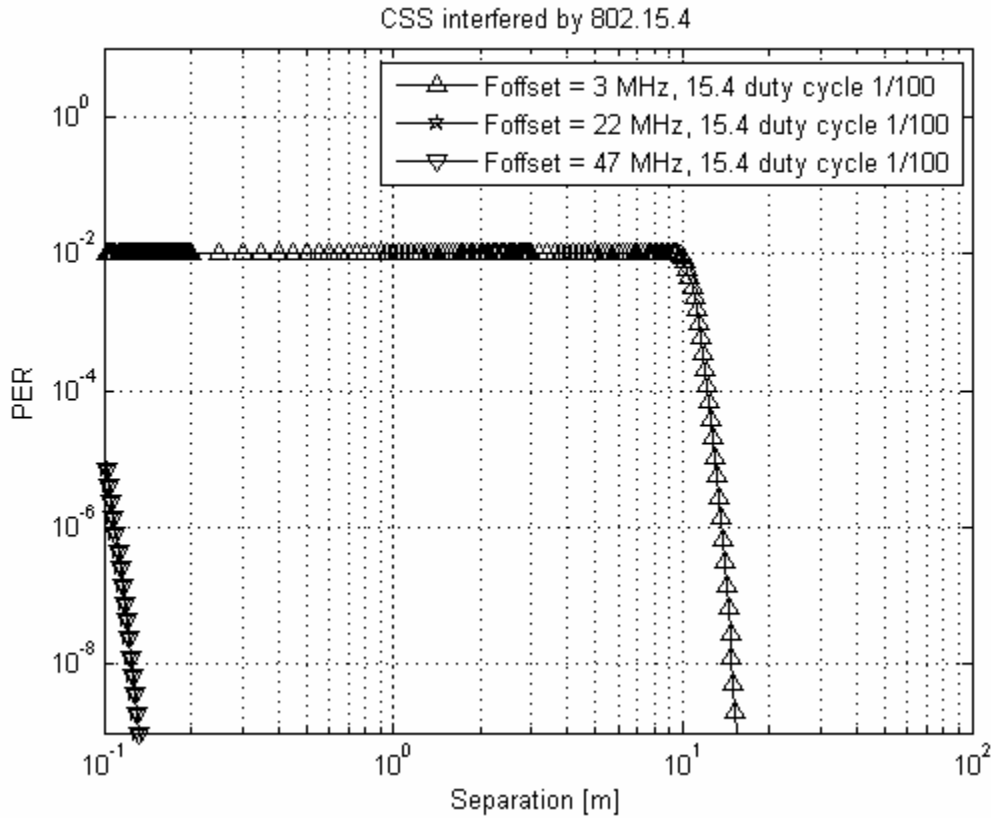

Figure E.3.3.7 —IEEE P802.15.4a CSS receiver (1Mbps), IEEE 802.15.4 interferer

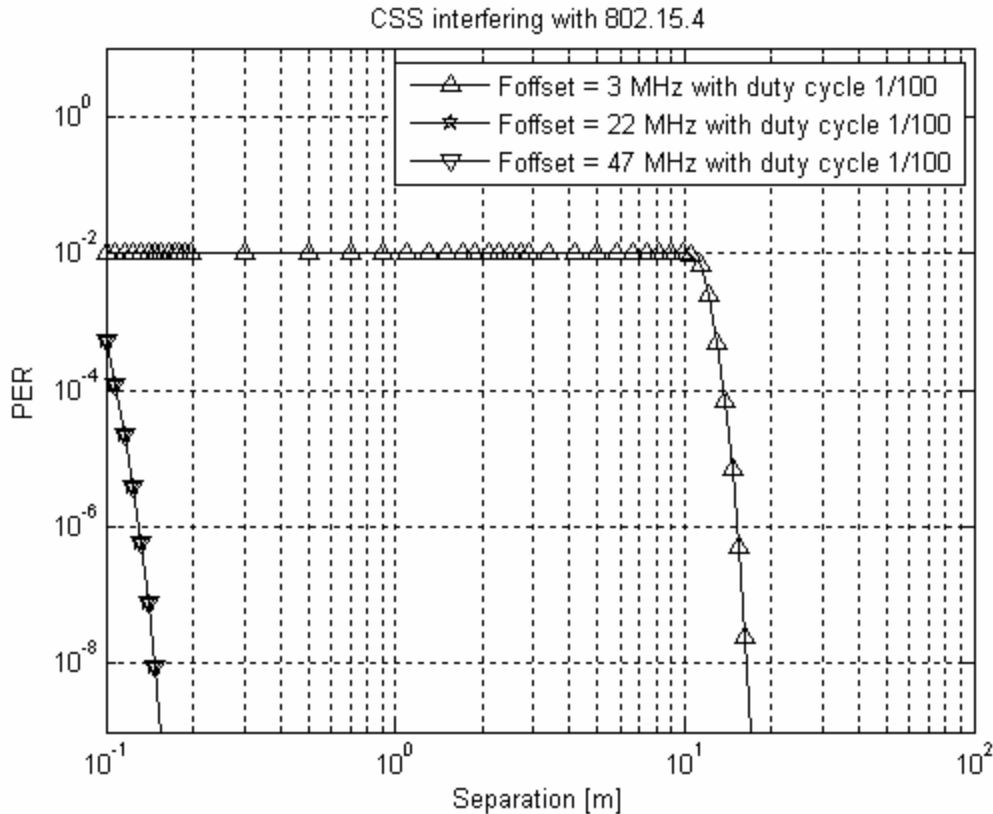

Figure E.3.3.8—IEEE 802.15.4 receiver, IEEE P802.15.4a CSS interferer

E.4 Notes on the calculations

The calculations for this annex were based on the formulas and descriptions from IEEE P802.15.2.

Add the following sections, yet to be completed :

E.5 Standards and proposed standards characterized for coexistence with IEEE 802.15.4a UWB devices between 3.1 and 10.6 GHz

This clause enumerates IEEE-compliant devices that are characterized and the devices that are not characterized for operation in proximity to IEEE 802.15.4a UWB devices.

The IEEE 802.15.4a UWB PHYs other than the sub-GHz PHY are specified for operation in the 3.1 – 10.6 GHz band.

Standards and proposed standards characterized in this annex for coexistence are

- Bluetooth™ (IEEE 802.15.1) – adjacent band
- P802.15.3 - adjacent band
- IEEE 802.11b,g – adjacent band
- IEEE 802.11a – in-band
- IEEE 802.15.4 – adjacent band
- IEEE 802.16a – in-band

Standards not characterized in this annex for coexistence are:

To be completed

E.6 General coexistence issues for IEEE 802.15.4a UWB devices between 3.1 and 10.6 GHz

To be completed

E.7 Coexistence performance for IEEE 802.15.4a UWB devices between 3.1 and 10.6 GHz

To be completed

E.8 Standards and proposed standards characterized for coexistence with IEEE 802.15.4a sub-GHz UWB devices

To be completed.

E.9 General coexistence issues for IEEE 802.15.4a sub-GHz UWB devices

To be completed

E.10 Coexistence performance for IEEE 802.15.4a sub-GHz UWB devices

To be completed

Annex F (informative) Regulatory requirements

Modify the section numbering, as follows :

F.1. IEEE 802.15.4

F.1.1 Introduction

F.1.2 Applicable U.S. (FCC) rules

F1.2.1 Section 15.35 of FCC CFR47

F1.2.2 Section 15.209 of FCC CFR47

F1.2.3 Section 15.205 of FCC CFR47

F1.2.4 Section 15.247 of FCC CFR47

F1.2.5 Section 15.249 of FCC CFR47

F.1.3 Applicable European rules

F1.3.1 European 2400 MHz band rules

F1.3.2 European 868–870 MHz band rules

F.1.4 Known Japanese rules

F.1.5 Emissions specification analysis with respect to known worldwide regulations

F.1.5.1 General analysis and impact of detector bandwidth and averaging rules

F.1.5.2 Frequency spreading and averaging effects specific to IEEE 802.15.4

F.1.6 Summary of out-of-band spurious emissions limits

F.1.7 Phase noise requirements inferred from regulatory limits

F.1.8 Summary of transmission power levels

Add the following sections, yet to be further completed :

F.2. IEEE 802.15.4a UWB

F.2.1 Introduction

To be completed

F.2.2 Applicable U.S. (FCC) rules

The FCC adopted "First report and order" in February 2002, which allows UWB operation with the following average emission limits (Table F2.1.1).

The peak EIRP limit being adopted in this Report and Order is 0 dBm when measured with a resolution bandwidth of 50 MHz and 20 log (RBW/50) dBm when measured with a resolution bandwidth ranging from 1 MHz to 50 MHz. RBW is the resolution bandwidth, in megahertz, actually employed. The minimum resolution bandwidth that may be employed is 1 MHz; the maximum resolution bandwidth that may be employed is 50 MHz.

Table F2.1.1 – UWB average emission limits, EIRP in dBm/MHz

Frequency Band (MHz)	Imaging below 960 MHz	Imaging, Mid-Frequency	Imaging, High frequency	Indoor applications	Hand held, including outdoor	Vehicular radar
0.009-960	FCC §15.209	FCC §15.209	FCC §15.209	FCC §15.209	FCC §15.209	FCC §15.209
960-1610	-65.3	-53.3	-65.3	-75.3	-75.3	-75.3

1610-1990 - 51.3 -41.3 - 51.3 -51.3 - 61.3 -61.3	-53.3	-51.3	-53.3	-53.3	-63.3	-61.3
1990-3100	-51.3	-41.3	-51.3	-51.3	-61.3	-61.3
3100-10600	-51.3	-41.3	-41.3	-41.3	-41.3	-61.3
10600- 22000	-51.3	-51.3	-51.3	-51.3	-61.3	-61.3
22000- 29000	-51.3	-51.3	-51.3	-51.3	-61.3	-41.3
Above 29000	-51.3	-51.3	-51.3	-51.3	-61.3	-51.3

F.2.3 Applicable European rules

→ to be updated in January 2006

In Europe, Draft ECC Decision **ECC/DEC/(06)AA** is in "public consultation" phase from the 24th of October until the 24th of December 2005. This version of the Decision allows UWB operation with the following emission limits (Table F2.3.1).

It should be noted that the ECC Decision intends to deliver a clear message that the band 6 to 9 GHz is identified in Europe for long-term UWB operation without additional mitigation techniques.

Some issues are expected to be solved in January 2006 thanks to the comments received during the public consultation. For example, it is not yet decided whether the Decision should restrict the use to indoor only and if so how this can be enforced.

Table F2.3.1 – UWB emission limits, EIRP in dBm/MHz

Frequency range	Maximum mean e.i.r.p. density (dBm/MHz)	Maximum peak e.i.r.p. density (dBm/50MHz)
Below 1.6 GHz	-90 dBm/MHz	-50 dBm/50MHz
1.6 to 2.7 GHz	-85 dBm/MHz	-45 dBm/50MHz
2.7 to 3.1 GHz	-70 dBm/MHz	-30 dBm/50MHz
3.1 to 4.8 GHz	-70 dBm/MHz	-30 dBm/50MHz
Note 1		
Note 2		
4.8 to 6 GHz	-70 dBm/MHz	-30 dBm/50MHz
6 to 9 GHz	-41.3 dBm/MHz	0 dBm/50MHz
9 to 10.6 GHz	-65 dBm/MHz	-25 dBm/50MHz
Above 10.6 GHz	-85 dBm/MHz	-45 dBm/50MHz

Note 1: In the frequency band 3.1 to 4.8 GHz, ECC has decided to investigate efficient mitigation techniques, such as amongst others DAA (Detect And Avoid) mechanisms in order to ensure compatibility of UWB devices with radio services in the band with a view of allowing UWB devices in this band with maximum mean e.i.r.p. density of -41.3 dBm/MHz and a maximum peak e.i.r.p. density of 0dBm/50MHz. Duty-cycle limitation has also been identified as a possible mitigation technique. ECC will review this decision in the light of the results of these investigations.

[Note for public consultation: Technical requirements for the Low Duty Cycle (LDC) mitigation may be solved before the final adoption of the Decision and therefore be incorporated as a separate note to the table of this Annex.]

Note 2: In the frequency band 4.2 to 4.8 GHz, UWB devices are permitted until 30 June 2010 with a maximum mean e.i.r.p density of -41.3 dBm/MHz and a maximum peak e.i.r.p density of 0dBm/50MHz

F.2.4 Applicable Japanese rules

To be completed

F.3. IEEE 802.15.4a CSS

To be completed